

MCD 3000 Softstarter



Instruction

MCD 3000 Inside Delta Connection Kits





MCD3000 Inside Delta Connection Kits

Section 1.0	■ Warnings	2
Section 2.0	■ Description	
	2.1 Overview	3
	2.2 Inside delta ratings	3
	2.3 Isolation	3
	2.4 Supply voltage	3
Section 3.0	■ Kit Installation	
	3.1 Overview	4
	3.2 Installation procedure	4
Section 4.0	■ Starter Installation	
	4.1 Inside delta connection	6
	4.2 Inside delta connection (bypassed)	6
	4.3 Semiconductor fuses	6
	4.2 Programming, functions and operation	6



The MCD3000 contains dangerous voltages when connected to line voltage. Only a competent electrician should carry out the electrical installation. Improper installation of the motor or the MCD3000 may cause equipment failure, serious injury or death. Follow this manual and National Electrical Codes (NEC®) and local safety codes.

■ Safety regulations

1. The soft starter must be disconnected from the mains if repair work is to be carried out.
2. The [STOP] on the control panel of the soft starter does not disconnect the equipment from the mains and thus is not to be used as a safety switch.



It is the responsibility of the user or the person installing the MCD3000 to provide proper grounding and branch circuit protection according to the National Electric Code (NEC®) and local codes.

■ Warning against unintended start

1. The motor can be brought to a stop by means of digital commands, bus commands or a local stop, while the soft starter is connected to the mains. If personal safety considerations make it necessary to ensure that no unintended start occurs, these stop functions are not sufficient.
2. A motor that has been stopped may start if faults occur in the electronics of the soft starter, or if the soft starter's Auto Reset function has been activated and a temporary fault in the supply mains or the motor connection ceases.

■ Symbols used in this manual

When reading this manual you will come across different symbols that require special attention. The symbols used are the following:



Indicates something to be noted by the reader



Indicates a general warning



Indicates a high voltage warning

■ Avoiding soft starter damage

Please read and follow all instructions in this manual. Additionally, take special note of the following:

1. Do not connect power factor correction capacitors to the soft starter output. Static power factor correction, if used, must be connected on the mains side of the soft starter.
2. Do not apply voltage to the MCD3000 control inputs. The inputs are active 24 VDC and must be controlled with potential free circuits.
3. When installed in non-ventilated enclosures, soft starters should be used with a bypass contactor to prevent excessive enclosure temperatures.
4. When bypassing a soft starter take care to ensure phase connections are correct. i.e. B1-T1, L2-T2, B3-T3.
5. When using the D.C.Brake function ensure the D.C.Braking contactor is connected across output terminals T2-T3 only and that it operates only when the braking function is operating. Incorrect connection or operation will cause soft starter damage.



Electrostatic Precaution: Electrostatic discharge (ESD). Many electronic components are sensitive to static electricity. Voltages so low that they cannot be felt, seen or heard, can reduce the life, affect performance, or completely destroy sensitive electronic components. When performing service, proper ESD equipment should be used to prevent possible damage from occurring.

■ Description

MCD3000 models MCD3185 ~ MCD3800 fitted with the appropriate Inside Delta Connection kit can be connected to the motor using the Inside Delta Connection method.

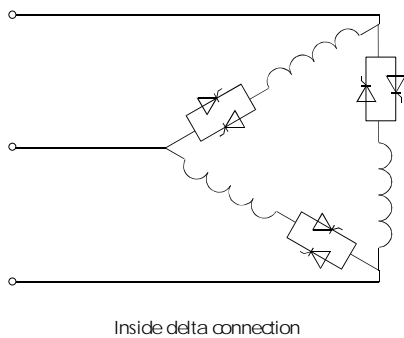
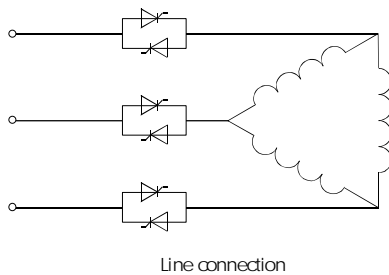

■ Inside delta ratings

Inside delta connection does not increase a soft starters rating. However, when connected inside the delta circuit of a motor, it is possible for a soft starter to control a motor with a FLC greater than that of the soft starter because the soft starter is controlling only phase current.

Phase current is 58% of line current and can be calculated as follows;

$$\text{Phase Current} = \frac{\text{Line Current}}{\sqrt{3}}$$

The above equation can be rewritten as follows in order to allow calculation of the maximum motor size (FLC) that a soft starter can control when connected within the delta circuit.

- Phase current x $\sqrt{3}$ = Line current
- Soft starter current x $\sqrt{3}$ = Max. motor current
- Soft starter current x 1.73 = Max. motor current

On the basis of the above equation it would appear logical that soft starters connected using the inside delta connection method can control motors 73% larger than the soft starters rating. For example, a soft starter rated at 100A could control a motor with a FLC rating of 173 Amps.

Unfortunately the 1.73 multiplier cannot be used because it fails to account for increased SCR heating when the soft starter is connected using the inside delta connection method.

The increased SCR heating associated with inside delta connection occurs because in order to maintain a given average current the SCR conduction angle must be shorter and pass a higher current than would be the case with normal line connection.

Heat generated within the SCR is an I^2t function. Therefore the SCRs in a soft starter connected using inside delta connection will be subject to increased heating during starting and stopping even though passing the same average current as a line connected soft starter.

When this extra SCR heating effect is taken into account the increase in motor handling capability for inside delta connection should be 1.5 not the theoretical 1.73 figure. Inside delta ratings for the MCD3000 range are calculated using the 1.5 figure.

■ Isolation

A line contactor or similar load break switch is required when using Inside Delta Connection. The line contactor is needed for safety and is a legal requirement. This is because with Inside Delta Connection one end of each motor winding remains connected to the supply when the soft starter is off. A line contactor is not normally required when using the line connection format.

■ Supply voltage

In normal line connection two SCRs block phase to phase voltage. In contrast when a soft starter is installed inside the delta circuit of a motor a single SCR blocks full phase to phase voltage. As a result the maximum supply voltage capability of the soft starter is reduced.

Consult the specification section of the MCD3000 operating instruction for MCD3000 supply voltage ratings.

Overview

To be capable of inside delta connection MCD3000 units must be fitted with an appropriate Inside Delta Connection kit.

MCD3000 Model	Inside Delta Kit
MCD3185	175G3043
MCD3220	175G3044
MCD3300	175G3045
MCD3315	175G3046
MCD3400	175G3047
MCD3500	175G3048
MCD3600	175G3049
MCD3700	175G3050
MCD3800	175G3051

The inside delta connection kits consist of two parts.

- A current transformer
- An Identity module.

Installation procedure

Step 1. Undo fixing screws (4) and remove front cover.

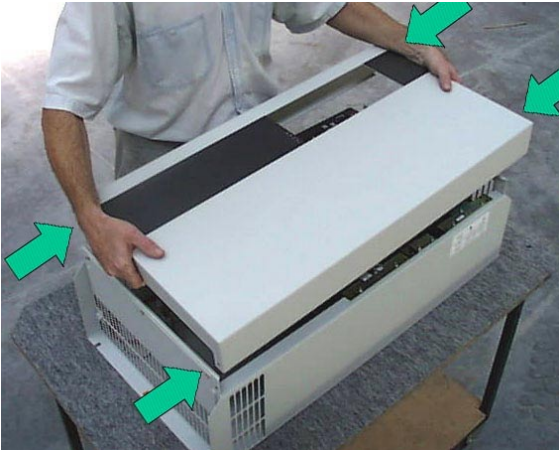

Step 2. Undo fixing screws (4) and lift off Control Module.

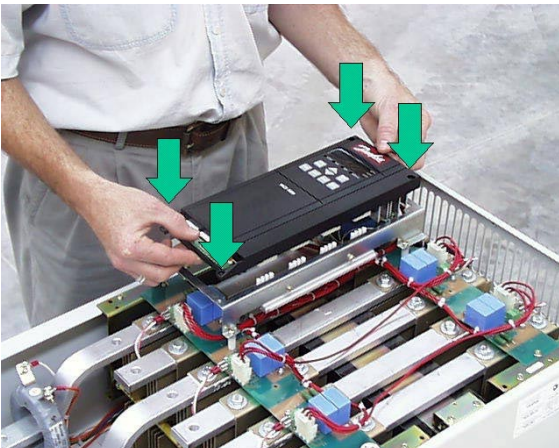

NB!

Lift the control module straight off. DO NOT Pivot.



Step 3. Unplug the three temperature detector plugs and the CT plug from the Identity Module.

All plugs have locating mechanisms to ensure they are correctly fitted. The three temperature detector plugs are interchangeable and can be connected to any of the temperature detector pins on the Identity Module.

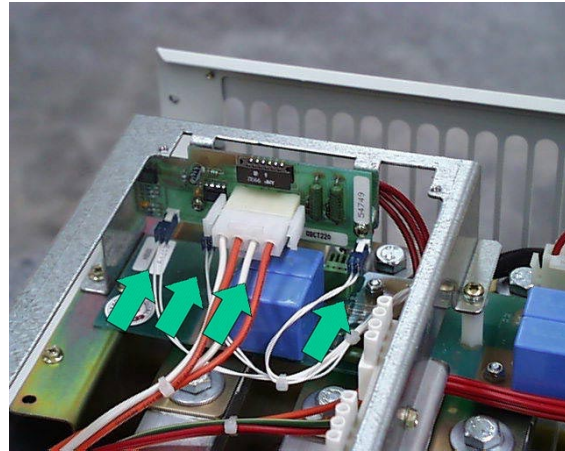

Step 4. Undo fixing screws (2), remove and discard the original Identity Module. Install the new inside delta connection identity module and reconnect the plug terminations.

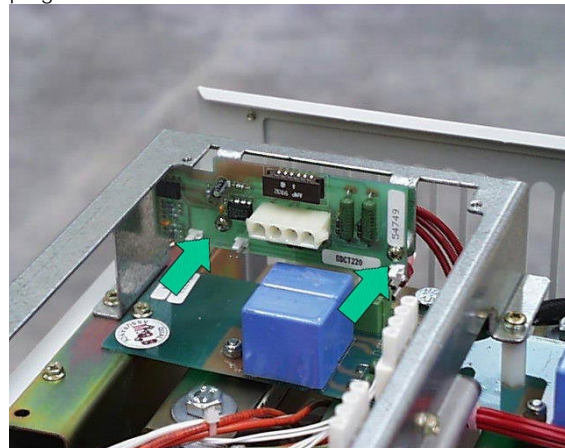

Step 5. Loosen the two (2) inside CT mounting screws. Fit the inside delta current transformer mounting plate as shown and retighten the CT mounting screws.

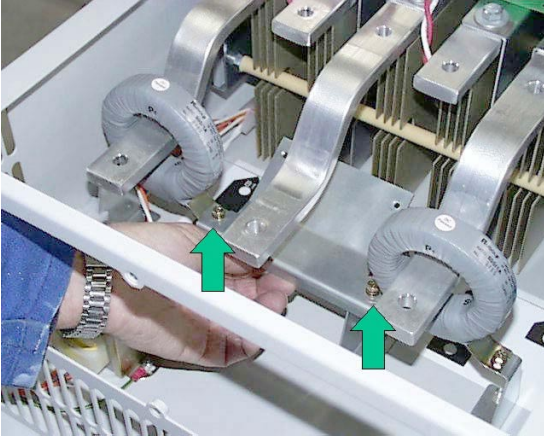

Step 6. Position the inside delta current transformer over the L2 bus bar and secure in place using the screws provided.

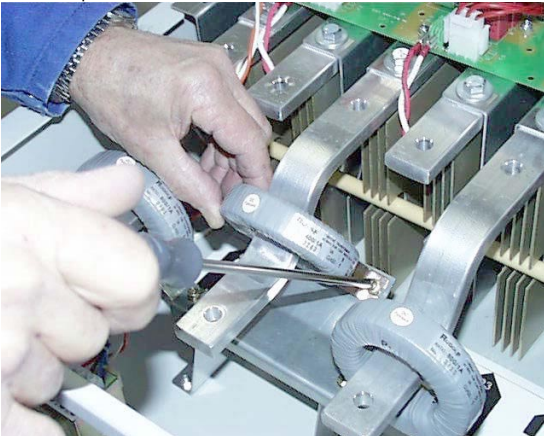

Step 7. Plug the secondary wires of the inside delta current transformer into the two socket on the new Identity Module.

Step 8. Refit the main control module and front cover.

■ **Power wiring – Inside delta connection**

Supply voltage must be connected to the starter input terminals L1, L2 & L3.
MCD3000 output terminals must be connected to one end of each motor winding. For example, T1-U1, T2-V1, T3-W1.
The remaining end of each winding must be connected to the supply voltage in such a way that the end of each winding is connected to a different phase from the input. For example, W2-L1, U2-L2, V2-L3.

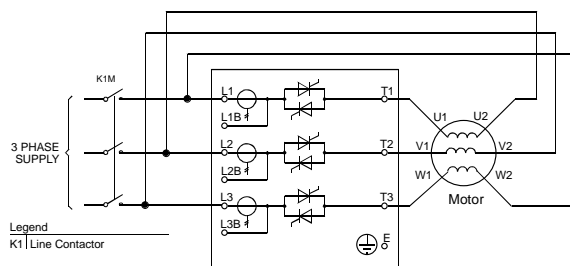

■ **Power wiring – Inside delta connection with bypass contactor**

A bypass contactor may be used when the MCD3000 is connected using the inside delta connection method.
The bypass contactor must be connected across the MCD3000 using the bypass termination points L1B to T1, L2B to T2 & L3B to T3.

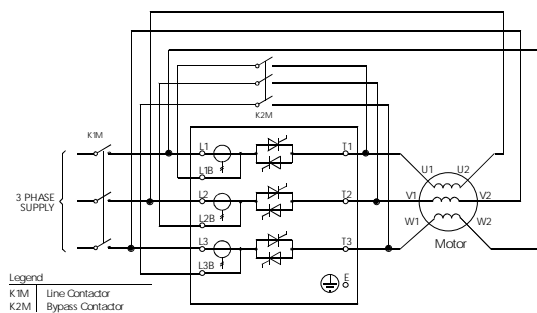

■ **Semiconductor fuses**

If semiconductor fuses are used they must also be installed inside the delta circuit of the motor.

■ **Programming, functions and operation**

The MCD3000 inside delta function is fully automatic.
No special user adjustment is required.
All MCD3000 functions and features are operative and unchanged.



MCD 3000 Softstarter



Instruction

VLT[®] frequency converters **BAUER** geared motors

Danfoss can accept no responsibility for possible errors in catalogues, brochures and other printed material. Danfoss reserves the right to alter its products without notice. This also applies to products already on order provided that such alterations can be made without subsequential changes being necessary in specifications already agreed. All trademarks in this material are property of the respective companies. Danfoss and the Danfoss logotype are trademarks of Danfoss A/S. All rights reserved.

