

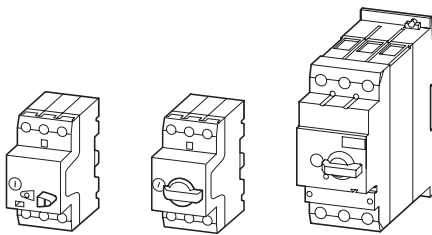

Moeller HPL0211-2004/2005

PKZM01, PKZM0, PKZM4 motor-protective circuit-breakers



	Page
Technical overview	8/2
System overview	8/3
Motor protection	
PKZM01 motor-protective circuit-breakers <i>xStart</i>	8/6
PKZM0 motor-protective circuit-breakers	8/8
PKZM4 motor-protective circuit-breakers	8/8
Motor-protective circuit-breakers for starter combinations	8/10
PKZM0-T transformer-protective circuit-breakers	8/10
PKZM0/SE00 compact starters	8/12
PKZM0/S00 high-capacity compact starters	8/12
Accessories	
Standard auxiliary contact	8/14
Trip-indicating auxiliary contact	8/16
Early-make auxiliary contacts	8/16
CL-PKZ0 current limiters	8/16
Shunt release	8/16
Undervoltage release	8/16
SE00-PKZ0 contact modules	8/18
S00-PKZ0 high-capacity contact modules	8/18
Suppressor for (high-capacity) contact modules	8/18
Accessories for (high-capacity) contact modules	8/18
Insulated enclosure engineering notes	8/20
Surface mounting enclosure	8/22
Installation enclosure	8/23
Busbar adapter	8/26
Three phase commoning link	8/27
Mounting and wiring system	8/29
MVS engineering notes	8/31
Actuating voltages	8/57
Tripping characteristics	8/69
Technical data	8/70
Dimensions	8/86

PKZ2 motor-protective circuit-breakers

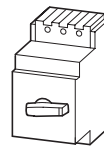

	Page
Technical overview	8/2
System overview	8/32
Overview of combination options	8/34
Motor protection	
PKZ2 motor-protective circuit-breakers	8/36
PKZ2-ZM../SE1A compact starters	8/38
PKZ2-ZM../S high-capacity compact starters	8/38
Motor protection modules	8/40
Accessories	
Standard auxiliary contact	8/44
Trip-indicating auxiliary contact	8/44
Short-circuit indicators	8/44
Current limiter	8/44
Shunt release	8/46
Undervoltage release	8/46
Remote operators	8/48
SE1A-PKZ2 contact modules	8/50
S-PKZ2 high-capacity contact modules	8/50
Suppressor	8/50
Base for EZ-PKZ2 separate mounting	8/50
Accessories for (high-capacity) contact modules	8/52
Insulated enclosures	8/54
System protection	
PKZ2 circuit-breaker	8/36
Components for system protection	8/42
Actuating voltages	8/61
Tripping characteristics	8/77
Technical data	8/79
Dimensions	8/96



"Motor Starter" supplementary catalogues, available from February 2005

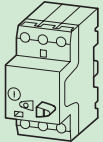
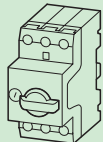
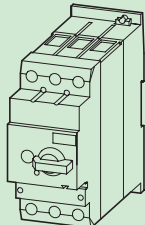
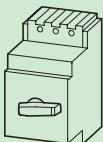

Moeller HPL0211-2004/2005

Motor-protective circuit-breaker	PKZM01	PKZM0	PKZM4	PKZ2				
								
Page	a 8/6	a 8/8	a 8/8	a 8/37				
Setting range overload release I_r	0.1 – 16 A	0.1 – 32 A	10 – 65 A	0.4 – 40 A				
Motor data at 400 V	Motor rating P	Rated operational current I_e	Motor rating P	Rated operational current I_e	Motor rating P	Rated operational current I_e	Motor rating P	Rated operational current I_e
	kW	A	kW	A	kW	A	kW	A
	0.06	0.21	0.06	0.21			0.12	0.41
	0.09	0.31	0.09	0.31			0.18	0.6
	0.12	0.41	0.12	0.41			0.25	0.8
	0.18	0.6	0.18	0.6			0.37	1.1
	0.25	0.8	0.25	0.8			0.55	1.5
	0.37	1.1	0.37	1.1			0.75	1.9
	0.55	1.5	0.55	1.5			1.1	2.6
	0.75	1.9	0.75	1.9			1.5	3.6
	1.1	2.6	1.1	2.6			2.2	5
	1.5	3.6	1.5	3.6			3	6.6
	2.2	5	2.2	5			4	8.5
	3	6.6	3	6.6			5.5	11.3
	4	8.5	4	8.5			7.5	15.2
	5.5	11.3	5.5	11.3	5.5	11.3	9	18.2
	7.5	15.2	7.5	15.2	7.5	15.2	11	21.7
					9	18.2	12.5	25
					11	21.7	15	29.3
					12.5	25	18.5	36
					15	29.3	20	40
					18.5	36	22	41
					20	40	30	55
					22	41	34	63
					30	55		
					34	63		

Moeller HPL0211-2004/2005

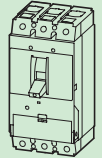
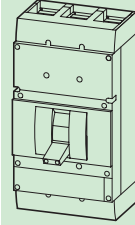
Motor-protective circuit-breaker	NZM...1-M...	NZM...2-M(E)	NZM...3-ME	NZM...4-ME				
								
Page	a 10/10	a 10/16	a 10/16	a 10/16				
Setting range overload release I_r	32 – 100 A	45 – 220 A	110 – 350 A	275 – 1400 A				
Motor data at 400 V	Motor rating P	Rated operational current I_e	Motor rating P	Rated operational current I_e	Motor rating P	Rated operational current I_e	Motor rating P	Rated operational current I_e
	kW	A	kW	A	kW	A	kW	A
	18.5	36			75	134		
	20	40			90	161		
	22	41			110	196		
	30	55	30	55	132	231		
	34	63	34	63	160	279	160	279
	37	68	37	68	200	349	200	349
	45	81	45	81			250	437
	55	99	55	99			315	544
							400	683
							450	769
							500	846
							560	947
							630	1065
							700	1184
							800	1353

Motor-protective circuit-breakers

Motor-protective circuit-breakers



Motor protection, transformer protection, line and cable protection

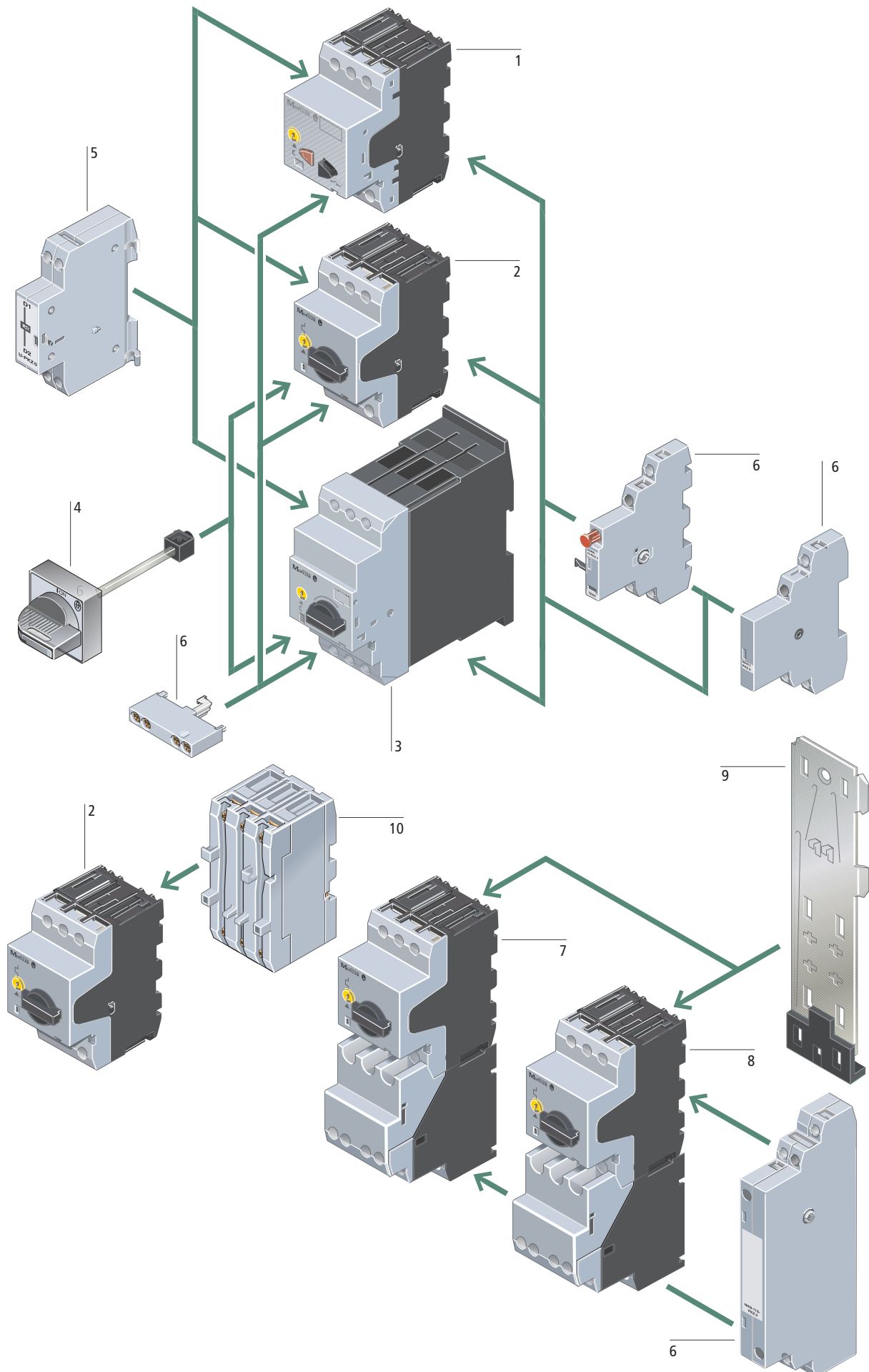

Moeller HPL0211-2004/2005

<p>Basic units</p> <hr/> <p>PKZM01 motor-protective circuit-breakers 1</p> <p>Rated operational current up to 16 A</p> <p>Switching capacity 50 kA/415 V</p> <p>Short-circuit release, fixed setting to $14 \times I_u$</p> <p>Overload release, adjustable $0.6 - 1 \times I_u$</p> <p>Single-phasing sensitive</p> <hr/> <p>a 8/6</p> <hr/> <p>PKZM0 motor-protective circuit-breakers 2</p> <p>Rated operational current up to 32 A</p> <p>Switching capacity 150/50 kA/415 V</p> <p>Short-circuit release, fixed setting to $14 \times I_u$</p> <p>Overload release, adjustable $0.6 - 1 \times I_u$</p> <p>Single-phasing sensitive</p> <p>With screws or springloaded terminals</p> <hr/> <p>a 8/8</p> <hr/> <p>PKZM4 motor-protective circuit-breakers 3</p> <p>Rated operational current up to 65 A</p> <p>Switching capacity 50 kA/400 V</p> <p>Short-circuit release, fixed setting to $14 \times I_u$</p> <p>Overload release, adjustable $0.6 - 1 \times I_u$</p> <p>Single-phasing sensitive</p> <hr/> <p>a 8/8</p> <hr/> <p>Compact starter 7</p> <p>Consisting of the PKZM0 motor-protective circuit-breaker and the fitted contact module</p> <p>Rated operational current up to 10 A</p> <p>4 kW/400 V</p> <p>Switching capacity 100 kA/415 V</p> <p>Classification type "1"</p> <p>Short-circuit release, fixed setting to $14 \times I_u$</p> <p>Overload release, adjustable $0.6 - 1 \times I_u$</p> <p>Single-phasing sensitive</p> <hr/> <p>a 8/57</p> <hr/> <p>High-capacity compact starters 8</p> <p>Consisting of the PKZM0 motor-protective circuit-breaker and the fitted high-capacity contact module</p> <p>Such as compact starter</p> <p>Switching capacity 100 kA/415 V</p> <p>Classification type "2"</p> <hr/> <p>a 8/13</p>	<p>Add-on functions</p> <hr/> <p>Standard auxiliary contact 6</p> <p>ON/OFF indication of motor-protective circuit-breaker</p> <p>Differential fault indication overload/short-circuit release</p> <p>ON/OFF for (high-capacity) contact module</p> <p>ON/OFF for starter combination</p> <p>With early-make contacts</p> <p>With screws or springloaded terminals</p> <hr/> <p>a 8/14</p> <hr/> <p>Voltage releases 5</p> <p>Undervoltage release</p> <p>Shunt release</p> <p>With screws or springloaded terminals</p> <hr/> <p>a 8/16</p> <hr/> <p>Current limiter 10</p> <p>Increases the switching capacity of the PKZM0-16, 20, 25 motor-protective circuit-breakers to 100 kA/440 V</p> <p>Can be used for individual and group protection.</p> <hr/> <p>a 8/17</p>	<p>Mounting accessories</p> <hr/> <p>Door coupling rotary handle IP65 4</p> <p>ON/OFF/Tripped switch position indication</p> <p>Lockable with 3 padlocks</p> <p>Integrated door/cover interlock</p> <p>Extendable by plug fit extension shaft</p> <hr/> <p>Handle latched in switch positions</p> <p>Optionally also without locking and door interlock function</p> <hr/> <p>a 8/24</p> <hr/> <p>Insulated enclosures</p> <p>Surface mounting enclosures, IP40, IP55 and IP65</p> <p>IP40 and IP55 front flush mounting enclosure</p> <hr/> <p>a 8/22</p> <hr/> <p>Mounting/wiring</p> <p>Component adapter for busbar mounting</p> <p>Three phase commoning link for side-by-side mounting</p> <p>Mounting kits for rapid mounting of direct-on-line, reversing and star-delta starters</p> <hr/> <p>a 8/26</p> <hr/> <p>Mounting/wiring 9</p> <p>Clip plate for (high-capacity) compact starter can be snap-fitted to EN 60715 top-hat rails</p> <hr/> <p>a 8/24</p>
--	--	--



Moeller HPL0211-2004/2005

Moeller HPL0211-2004/2005

Max. motor rating					Rated uninter- rupted current	Setting range		Screw terminals Type Article no.	Price See Price List	Std. pack
AC-3						Overload releases	Short-circuit release			
220 V	380 V	440 V	500 V	660 V	I_n A	I_r A	I_{sc} A			
230 V	400 V			690 V						
P	P	P	P	P						
kW	kW	kW	kW	kW						
Motor-protective circuit-breakers, type "1" and type "2" coordination										
-	-	-	-	0.06	0.16	0.1 - 0.16	2.2	PKZM01-0,16 278475		1 off
-	0.06	0.06	0.06	0.12	0.25	0.16 - 0.25	3.5	PKZM01-0,25 278476		
0.06	0.09	0.12	0.12	0.18	0.4	0.25 - 0.4	5.6	PKZM01-0,4 278477		
0.09	0.12	0.18	0.25	0.25	0.63	0.4 - 0.63	8.8	PKZM01-0,63 278478		
0.12	0.25	0.25	0.37	0.55	1	0.63 - 1	14	PKZM01-1 278479		
0.25	0.55	0.55	0.75	1.1	1.6	1 - 1.6	22	PKZM01-1,6 278480		
0.37	0.75	1.1	1.1	1.5	2.5	1.6 - 2.5	35	PKZM01-2,5 278481		
0.75	1.5	1.5	2.2	3	4	2.5 - 4	56	PKZM01-4 278482		
1.1	2.2	3	3	4	6.3	4 - 6.3	88	PKZM01-6,3 278483		
2.2	4	4	4	7.5	10	6.3 - 10	140	PKZM01-10 278484		
3	5.5	5.5	5.5	11	12	8 - 12	168	PKZM01-12 278485		
4	7.5	9	9	12.5	16	10 - 16	224	PKZM01-16 283390		

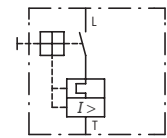
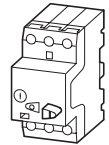

Notes

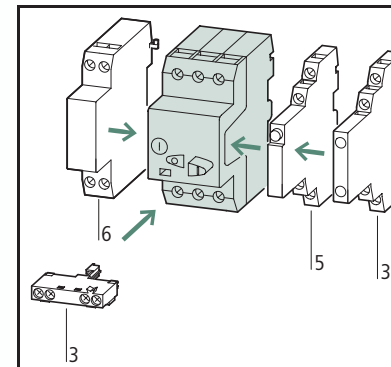

Accessories	Page
3 Standard auxiliary contact	a 8/15
5 Trip-indicating auxiliary contact	a 8/17
6 Shunt release, undervoltage release	a 8/17

Single-phasing sensitivity to IEC/EN 60947-4-1,
 VDE 0660 Part 102
 Can be snap-fit to IEC/EN 60715 top-hat rail with 7.5 or
 15 mm height



Max. motor rating AC-3					Rated unin- terrupted current	Setting range		Type Article no.	Price See Price List	Std. pack
220 V	380 V	440 V	500 V	660 V		Overload release	Short-circuit release			
230 V	400 V			690 V						
240 V	415 V									
<i>P</i>	<i>P</i>	<i>P</i>	<i>P</i>	<i>P</i>	I_u	I_r	I_m			
kW	kW	kW	kW	kW	A	A	A			

Motor-protective circuit-breakers, type "1" and type "2" coordination

				0.06	0.16	0.1 – 0.16	2.2	PKZM0-0,16 072730		1 off
	0.06	0.06	0.06	0.12	0.25	0.16 – 0.25	3.5	PKZM0-0,25 072731		
0.06	0.09	0.12	0.12	0.18	0.4	0.25 – 0.4	5.6	PKZM0-0,4 072732		
0.09	0.12	0.18	0.25	0.25	0.63	0.4 – 0.63	8.8	PKZM0-0,63 072733		
0.12	0.25	0.25	0.37	0.55	1	0.63 – 1	14	PKZM0-1 072734		
0.25	0.55	0.55	0.75	1.1	1.6	1 – 1.6	22	PKZM0-1,6 072735		
0.37	0.75	1.1	1.1	1.5	2.5	1.6 – 2.5	35	PKZM0-2,5 072736		
0.75	1.5	1.5	2.2	3	4	2.5 – 4	56	PKZM0-4 072737		
1.1	2.2	3	3	4	6.3	4 – 6.3	88	PKZM0-6,3 072738		
2.2	4	4	4	7.5	10	6.3 – 10	140	PKZM0-10 072739		
3	5.5	5.5	5.5	11	12	8 – 12	168	PKZM0-12 278486		
4	7.5	9	9	12.5	16	10 – 16	224	PKZM0-16 046938		
5.5	9	11	12.5	15	20	16 – 20	280	PKZM0-20 046988		
5.5	12.5	12.5	15	22	25	20 – 25	350	PKZM0-25 046989		
7.5	15	15	22	30	32	25 – 32	448	PKZM0-32 278489		

Motor-protective circuit-breakers, type "1" and type "2" coordination

4	7.5	9	9	12.5	16	10 – 16	224	PKZM4-16 222350		1 off
5.5	12.5	12.5	15	22	25	16 – 25	350	PKZM4-25 222352		
7.5	15	17.5	22	22	32	25 – 32	448	PKZM4-32 222353		
11	20	22	24	30	40	32 – 40	560	PKZM4-40 222354		
14	25	30	30	45	50	40 – 50	700	PKZM4-50 222355		
17	30	37	37	55	58	50 – 58	812	PKZM4-58 222394		
18.5	34	37	45	55	65	55 – 63	882	PKZM4-63 222413		

Screw and springloaded terminals		Springloaded terminals		Std. pack	Notes
Type Article no.	Price See Price List	Type Article no.	Price See Price List		

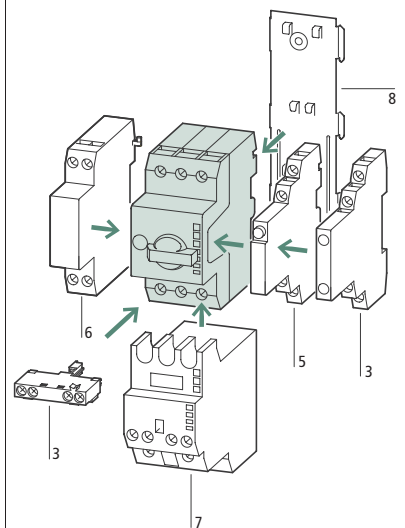
PKZM0-0,16-SC 229828		PKZM0-0,16-C 229669		1 off	 <p>Accessories</p> <table border="1"> <thead> <tr> <th>Accessories</th> <th>Page</th> </tr> </thead> <tbody> <tr> <td>3 Standard auxiliary contact</td> <td>a 8/15</td> </tr> <tr> <td>5 Trip-indicating auxiliary contact</td> <td>a 8/17</td> </tr> <tr> <td>6 Shunt release, undervoltage release</td> <td>a 8/17</td> </tr> <tr> <td>7 Contact module, high-capacity contact module</td> <td>a 8/19</td> </tr> <tr> <td>8 Clip plate</td> <td>a 8/24</td> </tr> </tbody> </table> <p>Single-phasing sensitivity to IEC/EN 60947-4-1, VDE 0660 Part 102 Can be snap-fit to IEC/EN 60715 top-hat rail with 7.5 or 15 mm height ⊕ PTB 02 ATEX 3151, see manual a 8/25</p>	Accessories	Page	3 Standard auxiliary contact	a 8/15	5 Trip-indicating auxiliary contact	a 8/17	6 Shunt release, undervoltage release	a 8/17	7 Contact module, high-capacity contact module	a 8/19	8 Clip plate	a 8/24
Accessories	Page																
3 Standard auxiliary contact	a 8/15																
5 Trip-indicating auxiliary contact	a 8/17																
6 Shunt release, undervoltage release	a 8/17																
7 Contact module, high-capacity contact module	a 8/19																
8 Clip plate	a 8/24																
PKZM0-0,25-SC 229829		PKZM0-0,25-C 229670															
PKZM0-0,4-SC 229830		PKZM0-0,4-C 229671															
PKZM0-0,63-SC 229831		PKZM0-0,63-C 229672															
PKZM0-1-SC 229832		PKZM0-1-C 229673															
PKZM0-1,6-SC 229833		PKZM0-1,6-C 229674															
PKZM0-2,5-SC 229834		PKZM0-2,5-C 229675															
PKZM0-4-SC 229835		PKZM0-4-C 229676															
PKZM0-6,3-SC 229836		PKZM0-6,3-C 229677															
PKZM0-10-SC 229837		PKZM0-10-C 229678															
PKZM0-12-SC 278487		PKZM0-12-C 278488															
PKZM0-16-SC 229838		PKZM0-16-C 229679															

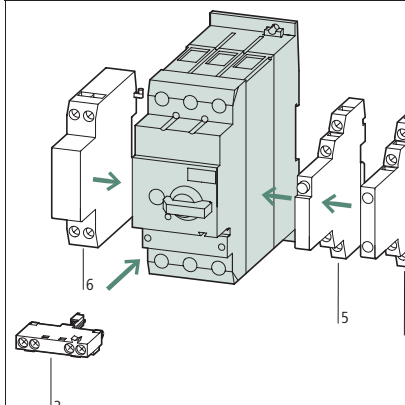
					 <p>Accessories</p> <table border="1"> <thead> <tr> <th>Accessories</th> <th>Page</th> </tr> </thead> <tbody> <tr> <td>3 Standard auxiliary contact</td> <td>a 8/15</td> </tr> <tr> <td>5 Trip-indicating auxiliary contact</td> <td>a 8/17</td> </tr> <tr> <td>6 Shunt release, undervoltage release</td> <td>a 8/17</td> </tr> </tbody> </table> <p>Single-phasing sensitivity to IEC/EN 60947-4-1, VDE 0660 Part 102 Can be snap-fit to IEC/EN 60715 top-hat rail with 7.5 or 15 mm height ⊕ PTB 02 ATEX 3153, see manual a 8/25</p>	Accessories	Page	3 Standard auxiliary contact	a 8/15	5 Trip-indicating auxiliary contact	a 8/17	6 Shunt release, undervoltage release	a 8/17
Accessories	Page												
3 Standard auxiliary contact	a 8/15												
5 Trip-indicating auxiliary contact	a 8/17												
6 Shunt release, undervoltage release	a 8/17												

Max. motor rating AC-3					Rated uninterrupted current	Setting range		Screw terminals Type Article no.	Std. pack
220 V	380 V	440 V	500 V	660 V		Overload release	Short-circuit release		
230 V	400 V			690 V				Price See Price List	
240 V	415 V								
<i>P</i>	<i>P</i>	<i>P</i>	<i>P</i>	<i>P</i>	<i>I_u</i>	<i>I_r</i>	<i>I_m</i>		
kW	kW	kW	kW	kW	A	A	A		

Motor-protective circuit-breakers for starter combinations

Short-circuit protective breaker without overload function

					0.06	0.16	-	2.2	PKM0-0,16 072720	1 off
	0.06	0.06	0.06	0.12	0.25	-	3.5	PKM0-0,25 072721		
	0.06	0.09	0.12	0.12	0.18	0.4	-	5.6	PKM0-0,4 072722	
	0.09	0.12	0.18	0.25	0.25	0.63	-	8.8	PKM0-0,63 072723	
	0.12	0.25	0.25	0.38	0.55	1	-	14	PKM0-1 072724	
	0.25	0.37	0.55	0.75	1.1	1.6	-	22	PKM0-1,6 072725	
	0.37	0.75	1.1	1.1	1.5	2.5	-	35	PKM0-2,5 072726	
	0.75	1.5	1.5	2.2	3	4	-	56	PKM0-4 072727	
	1.1	2.2	3	3	4	6.3	-	88	PKM0-6,3 072728	
	2.2	4	4	4	7.5	10	-	140	PKM0-10 072729	
	3	5.5	5.5	5.5	11	12	-	168	PKM0-12 278490	
	4	7.5	9	9	12.5	16	-	224	PKM0-16 044502	2 off
	5.5	9	11	12.5	15	20	-	280	PKM0-20 203594	1 off
	5.5	12.5	12.5	15	22	25	-	350	PKM0-25 044503	2 off
	7.5	15	15	22	30	32	-	448	PKM0-32 278491	1 off

Transformer-protective circuit-breakers

					0.16	0.1 - 0.16	2.4	PKZM0-0,16-T 088907	1 off	
					0.25	0.16 - 0.25	4.25	PKZM0-0,25-T 088908		
					0.4	0.25 - 0.4	6.8	PKZM0-0,4-T 088909		
					0.63	0.4 - 0.63	12	PKZM0-0,63-T 088910		
					1	0.63 - 1	20	PKZM0-1-T 088911		
					1.6	1 - 1.6	32	PKZM0-1,6-T 088912		
					2.5	1.6 - 2.5	50	PKZM0-2,5-T 088913		
					4	2.5 - 4	84	PKZM0-4-T 088914		
					6.3	4 - 6.3	141	PKZM0-6,3-T 088915		
					10	6.3 - 10	224	PKZM0-10-T 088916		
					12	8 - 12	224	PKZM0-12-T 278492		
					16	10 - 16	358	PKZM0-16-T 088917		
					20	16 - 20	380	PKZM0-20-T 088918		
					25	20 - 25	420	PKZM0-25-T 278493		

Notes

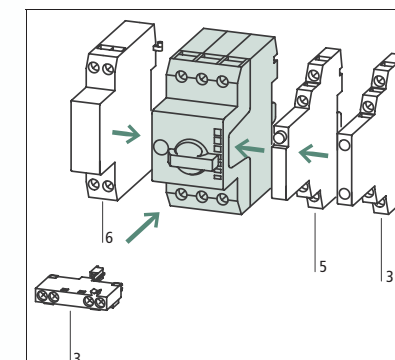

When using the PKM0 as short-circuit protection for motors with heavy starting duty, the rated operational current I_e must be over-dimensioned during engineering with the following factors:
 CLASS 5 = 1.0
 CLASS 10 = 1.0
 CLASS 15 = 1.22
 CLASS 20 = 1.41
 CLASS 25 = 1.58
 CLASS 30 = 1.73
 CLASS 35 = 1.89
 CLASS 40 = 2.0

Accessories	Page
3 Standard auxiliary contact	a 8/15
5 Trip-indicating auxiliary contact	a 8/17
6 Shunt releases, overvoltage release	a 8/17
Additional accessories	a 8/24

Can be snap-fitted to IEC/EN 60715 top-hat rail with 7.5 or 15 mm height
 Assignment of the short-circuit protective breakers and contactors in "Fuseless motor-starter combinations" section.
 An appropriate overload relay must be fitted to protect motors against overload.

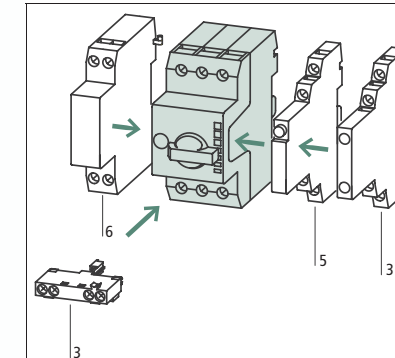

Accessories	Page
3 Standard auxiliary contact	a 8/15
5 Trip-indicating auxiliary contact	a 8/17
6 Shunt release, undervoltage release	a 8/17

For the protection of transformers with a high inrush current
 Cannot be combined with high-capacity contact module
 Can be snap-fitted to IEC/EN 60715 top-hat rail with 7.5 or 15 mm height
 Single-phasing sensitivity to IEC/EN 60947-4-1, VDE 0660 Part 102

Moeller HPL0211-2004/2005

Max. motor rating AC-3					Rated uninterrupted current	Setting range	
220 V 230 V 240 V	380 V 400 V 415 V	440 V	500 V	660 V 690 V		Overload release	Short-circuit release
P	P	P	P	P	I_u	I_r	I_m
kW	kW	kW	kW	kW	A	A	A



Compact starters, type "1" coordination

-	-	-	-	0.06	0.16	0.1 - 0.16	2.2
-	0.06	0.06	0.06	0.12	0.25	0.16 - 0.25	3.5
0.06	0.09	0.12	0.12	0.18	0.4	0.25 - 0.4	5.6
0.09	0.12	0.18	0.25	0.25	0.63	0.4 - 0.63	8.8
0.12	0.25	0.25	0.37	0.55	1	0.63 - 1	14
0.25	0.55	0.55	0.75	1.1	1.6	1 - 1.6	22
0.37	0.75	1.1	1.1	1.5	2.5	1.6 - 2.5	35
0.75	1.5	1.5	2.2	3	4	2.5 - 4	56
1.1	2.2	3	3	4	6.3	4 - 6.3	88
2.2	4	4	4	-	10	6.3 - 10	140

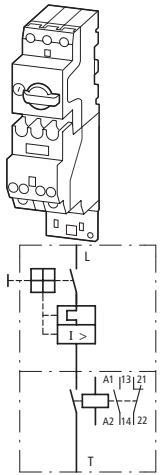

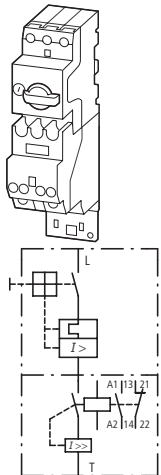

High-capacity compact starter, classification type "2"

-	-	-	-	0.06	0.16	0.1 - 0.16	2.2
-	0.06	0.06	0.06	0.12	0.25	0.16 - 0.25	3.5
0.06	0.09	0.12	0.12	0.18	0.4	0.25 - 0.4	5.6
0.09	0.12	0.18	0.25	0.25	0.63	0.4 - 0.63	8.8
0.12	0.25	0.25	0.37	0.55	1	0.63 - 1	14
0.25	0.55	0.55	0.75	1.1	1.6	1 - 1.6	22
0.37	0.75	1.1	1.1	1.5	2.5	1.6 - 2.5	35
0.75	1.5	1.5	2.2	3	4	2.5 - 4	56
1.1	2.2	3	3	4	6.3	4 - 6.3	88
2.2	4	4	4	-	10	6.3 - 10	140

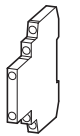
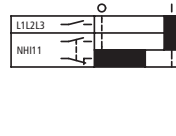
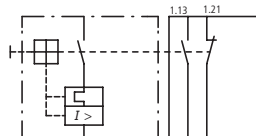
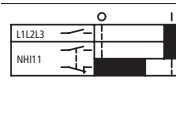
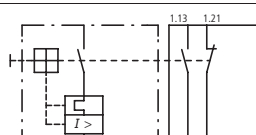
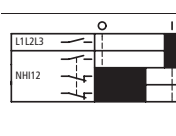
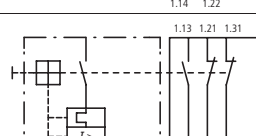
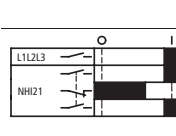
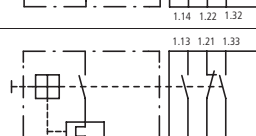

Moeller HPL0211-2004/2005

Type Article no.	Price See Price List	Std. pack	Notes																
PKZM0-0,16/SE00-11(230V50HZ,240V60) 050286		1 off	<p>Accessories</p> <table border="1"> <thead> <tr><th>Accessories</th><th>Page</th></tr> </thead> <tbody> <tr><td>3 Standard auxiliary contact</td><td>a 8/14</td></tr> <tr><td>4 Standard auxiliary contact for (high-capacity) compact starters</td><td>a 8/14</td></tr> <tr><td>5 Trip-indicating auxiliary contact</td><td>a 8/16</td></tr> <tr><td>6 Shunt release, undervoltage release</td><td>a 8/16</td></tr> </tbody> </table> <p>Single-phasing sensitivity to IEC/EN 60947-4-1, VDE 0660 Part 102 Can be snap fitted on one or two IEC/EN 60715 top-hat rails, with 7.5 or 15 mm height at a spacing of 75/100/125 mm</p> <p>(High-capacity) compact starter DC version: suppressor always integrated</p> <p>Coil voltage:</p> <table border="1"> <tbody> <tr><td>12 V DC</td></tr> <tr><td>24 V DC</td></tr> <tr><td>48 V DC</td></tr> <tr><td>60 V DC</td></tr> <tr><td>110 V DC</td></tr> <tr><td>220 V DC</td></tr> </tbody> </table> <p>Circuit diagram</p> <p>1 M/1 B auxiliary contact built into the (high-capacity) contact module</p>	Accessories	Page	3 Standard auxiliary contact	a 8/14	4 Standard auxiliary contact for (high-capacity) compact starters	a 8/14	5 Trip-indicating auxiliary contact	a 8/16	6 Shunt release, undervoltage release	a 8/16	12 V DC	24 V DC	48 V DC	60 V DC	110 V DC	220 V DC
Accessories	Page																		
3 Standard auxiliary contact	a 8/14																		
4 Standard auxiliary contact for (high-capacity) compact starters	a 8/14																		
5 Trip-indicating auxiliary contact	a 8/16																		
6 Shunt release, undervoltage release	a 8/16																		
12 V DC																			
24 V DC																			
48 V DC																			
60 V DC																			
110 V DC																			
220 V DC																			
PKZM0-0,25/SE00-11(230V50HZ,240V60) 051145																			
PKZM0-0,4/SE00-11(230V50HZ,240V60HZ) 052704																			
PKZM0-0,63/SE00-11(230V50HZ,240V60) 053010																			
PKZM0-1/SE00-11(230V50HZ,240V60HZ) 053430																			
PKZM0-1,6/SE00-11(230V50HZ,240V60HZ) 053439																			
PKZM0-2,5/SE00-11(230V50HZ,240V60HZ) 053448																			
PKZM0-4/SE00-11(230V50HZ,240V60HZ) 053457																			
PKZM0-6,3/SE00-11(230V50HZ,240V60HZ) 053466																			
PKZM0-10/SE00-11(230V50HZ,240V60HZ) 058835																			
PKZM0-0,16/S00-11(230V50HZ,240V60HZ) 044520		1 off	<p>Single-phasing sensitivity to IEC/EN 60947-4-1, VDE 0660 Part 102 Can be snap fitted on one or two IEC/EN 60715 top-hat rails, with 7.5 or 15 mm height at a spacing of 75/100/125 mm</p> <p>(High-capacity) compact starter DC version: suppressor always integrated</p> <p>Coil voltage:</p> <table border="1"> <tbody> <tr><td>12 V DC</td></tr> <tr><td>24 V DC</td></tr> <tr><td>48 V DC</td></tr> <tr><td>60 V DC</td></tr> <tr><td>110 V DC</td></tr> <tr><td>220 V DC</td></tr> </tbody> </table> <p>Circuit diagram</p> <p>1 M/1 B auxiliary contact built into the (high-capacity) contact module</p>	12 V DC	24 V DC	48 V DC	60 V DC	110 V DC	220 V DC										
12 V DC																			
24 V DC																			
48 V DC																			
60 V DC																			
110 V DC																			
220 V DC																			
PKZM0-0,25/S00-11(230V50HZ,240V60HZ) 044529																			
PKZM0-0,4/S00-11(230V50HZ,240V60HZ) 044538																			
PKZM0-0,63/S00-11(230V50HZ,240V60HZ) 044547																			
PKZM0-1/S00-11(230V50HZ,240V60HZ) 044556																			
PKZM0-1,6/S00-11(230V50HZ,240V60HZ) 044565																			
PKZM0-2,5/S00-11(230V50HZ,240V60HZ) 044574																			
PKZM0-4/S00-11(230V50HZ,240V60HZ) 044583																			
PKZM0-6,3/S00-11(230V50HZ,240V60HZ) 044592																			
PKZM0-10/S00-11(230V50HZ,240V60HZ) 044601																			

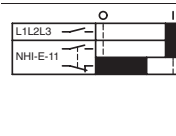
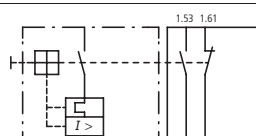
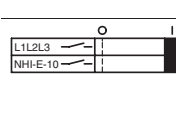
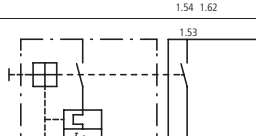
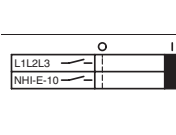
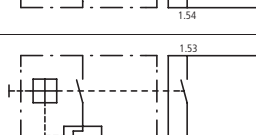
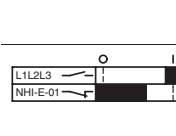
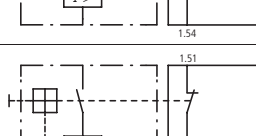
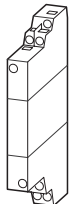
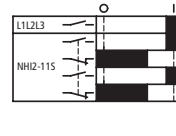
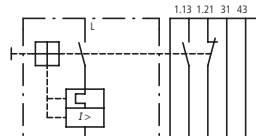
Contacts	Contact sequence	Contact sequence	For use with	Type suffix Article no. for ordering with basic unit	Price See Price List	Std. pack
M = Make B = Break						
Standard auxiliary contact						
for motor-protective circuit-breaker and (high-capacity) compact starter						
	1 M 1 B			PKZM01 PKZM0 PKZM4 PKZM0-T PKM0	+NHI11-PKZO 073233	1 off
	1 M 1 B				+NHI11-PKZO-C 232151	5 off
	1 M 2 B				+NHI12-PKZO 073234	1 off
	2 M 1 B				+NHI21-PKZO 073235	
	1 M 1 B				+NHI-E-11-PKZO 082883	
	1 M -				+NHI-E-10-PKZO 082885	
	1 M -				+NHI-E-10-PKZO-C 232152	5 off
	- 1 B				+NHI-E-01-PKZO-C 232153	5 off
	2 x 1 M 2 x 1 B			PKZM0/S(E)	+NHI2-115-PKZO 073236	1 off



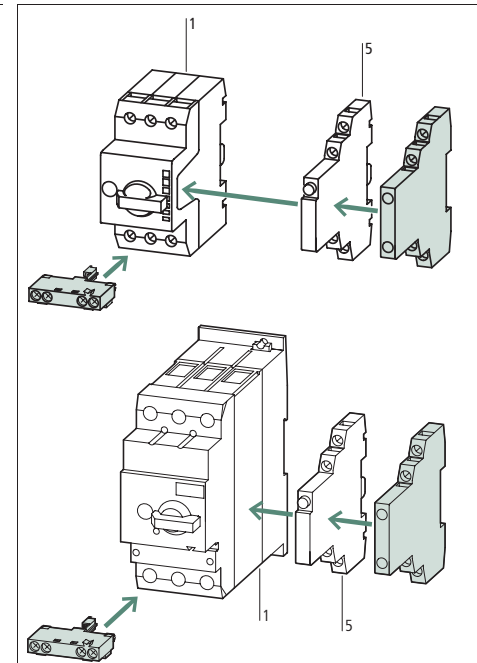

Type Article no. when ordered separately	Price See Price List	Std. pack	Notes
NHI11-PKZO 072896		5 off	Can be fitted on the right on: motor-protective circuit-breaker, transformer-protective circuit-breaker, motor-protective circuit-breaker for starter combinations and (high performance) compact starters Can be combined with: AGM, NHI-E-... trip-indicating auxiliary contact Cannot be combined with: NHI2-115-PKZO standard auxiliary contact
NHI11-PKZO-C 229680			
NHI12-PKZO 072895			
NHI21-PKZO 072894			
NHI-E-11-PKZO 082882			Can be fitted to motor-protective circuit-breakers, transformer-protective circuit-breakers, motor-protective circuit-breakers for starter combinations from serial number. 01. 45 mm (PKZM0 and PKZM01) or 55 mm (PKZM4) widths of the motor-protective circuit-breakers remain unchanged.
NHI-E-10-PKZO 082884			
NHI-E-10-PKZO-C 229681			
NHI-E-01-PKZO-C 229682			
NHI2-115-PKZO 072897		2 off	Can be fitted to the right of: (High-capacity) compact starters Can be combined with: NHI-E-... Cannot be combined with: NHI...-PKZO standard auxiliary contact AGM2-...PKZO trip-indicating auxiliary contact Differential status indication of the main contacts of motor-protective circuit-breaker and (high-capacity) contact module

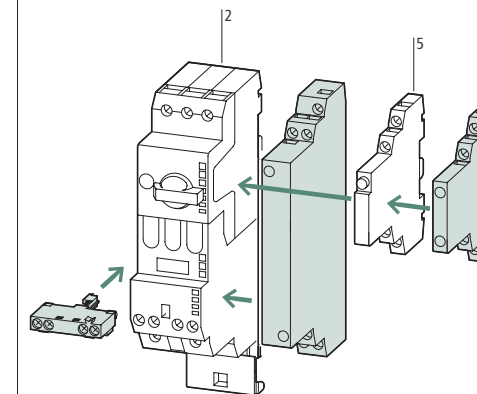

Accessories	Page
1 Motor-protective circuit-breakers	a 8/8
5 Trip-indicating auxiliary contact	a 8/16
Additional accessories	a 8/24

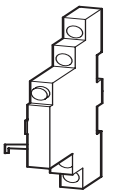
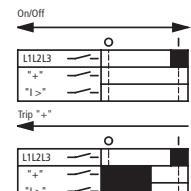
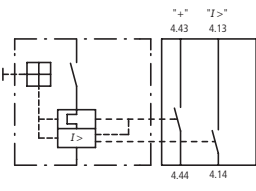

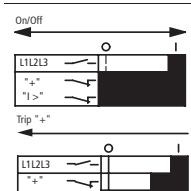
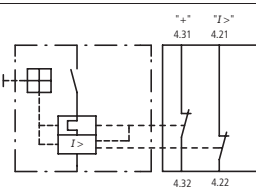
Accessories	Page
2 Compact starter, high-capacity compact starter	a 8/57
5 Trip-indicating auxiliary contact	a 8/16
Additional accessories	a 8/24

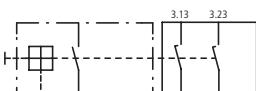
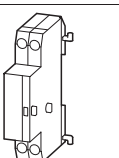
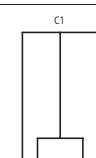
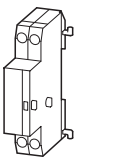
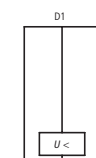
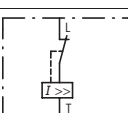
Contacts	Contact sequence	Contact sequence	For use with	Type suffix Article no. for ordering with basic unit	Price See Price List	Std. pack
M = Make B = Break						
Trip-indicating auxiliary contact for motor-protective circuit-breaker and (high-capacity) compact starter						
	2 x 1 M			PKZM0 PKZM4 PKZM0-T PKM0 PKZM01	+AGM2-10-PKZ0 073237	1 off
	2 x 1 B			PKZM0 PKZM4 PKZM0-T PKM0 PKZM01	+AGM2-01-PKZ0 073238	1 off
Early-make auxiliary contacts for motor-protective circuit-breaker and (high-capacity) compact starter						
	2 M			PKZM0 PKZM0-T PKM0	+VHI20-PKZ0 207792	1 off
				PKZM01	+VHI20-PKZ01 278494	5 offk
Shunt release						
	Screw terminals			PKZM0 PKZM4 PKZM0-T PKM0 PKZM01	+A-PKZ0(230V50HZ) 073302	1 off
	Spring-loaded terminals				+A-PKZ0-C(230V50HZ) 232155	2 off
	Screw terminals				+A-PKZ0(24VDC) 073306	1 off
	Spring-loaded terminals				+A-PKZ0-C(24VDC) 232156	2 off
Undervoltage release						
	Screw terminals			PKZM0 PKZM4 PKZM0-T PKM0 PKZM01	+U-PKZ0(230V50HZ) 073250	1 off
	Spring-loaded terminals				+U-PKZ0-C(230V50HZ) 232154	2 off
Current limiter To enhance the switching capacity of non-inherently safe PKZM0-16, -20, -25 motor-protective circuit-breakers to 150 kA/440 V						
				PKZM0 PKZM4 PKZM01		

Type Article no. when ordered separately	Price See Price List	Std. pack	Notes
AGM2-10-PKZ0 072898		2 off	Can be fitted to the right of motor-protective circuit-breakers and (high-capacity) compact starters. Can be combined with: Standard auxiliary contact NHI11-PKZ0 NHI12-PKZ0 NHI21-PKZ0 NHI-E-...
AGM2-01-PKZ0 072899		2 off	Cannot be combined with: Standard auxiliary contact NHI2-11S-PKZ0 Differential indication: a) General trip indication (overload) b) Short-circuit trip Local short-circuit indication by red indicator, manually resettable.
VHI20-PKZ0 203595		2 off	Can be fitted to front on motor-protective circuit-breaker, 45 mm width of the motor-protective circuit-breaker remains unchanged.
VHI20-PKZ01 278495		5 off	For early energization of undervoltage release, e.g. in Emergency-Stop circuits to EN 60204.
A-PKZ0(230V50HZ) 073187		2 off	Can be fitted to the left of: Motor-protective circuit-breaker and (high-capacity) compact starter
A-PKZ0-C(230V50HZ) 229684		2 off	Cannot be combined with: U-PKZ0 undervoltage release
A-PKZ0(24VDC) 073200		2 off	DC: Intermittent operation 5 s
A-PKZ0-C(24VDC) 229685		2 off	
U-PKZ0(230V50HZ) 073135		2 off	Can be fitted to the left of: Motor-protective circuit-breaker and (high-capacity) compact starter
U-PKZ0-C(230V50HZ) 229683		2 off	Cannot be combined with: A-PKZ0 shunt release When combined with circuit-breaker, can be used as Emergency-Stop device to IEC/EN 60204.
CL-PKZ0 082881		1 off	Max. rated operational voltage $U_e = 690$ V, rated uninterrupted current $I_u = 63$ A Can be used for individual and group protection For group protection and in combination with PKZM4, order additional BK25/3 incoming terminal if required. Mounting next to or behind the motor-protective circuit-breaker. PKZM4: 16 – 63 A: 100 kA/400 V PKZM4: 16 – 63 A: 10 kA/690 V

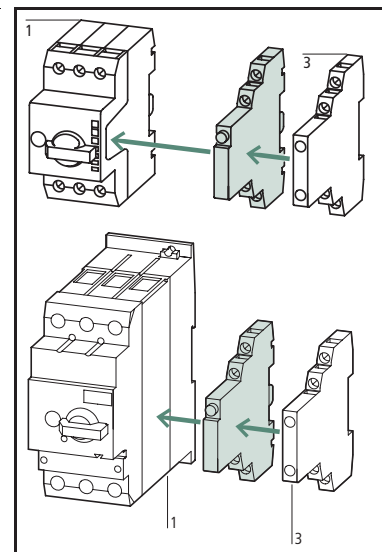

Accessories	Page
1 Motor-protective circuit-breakers	a 8/8
3 Standard auxiliary contact	a 8/14

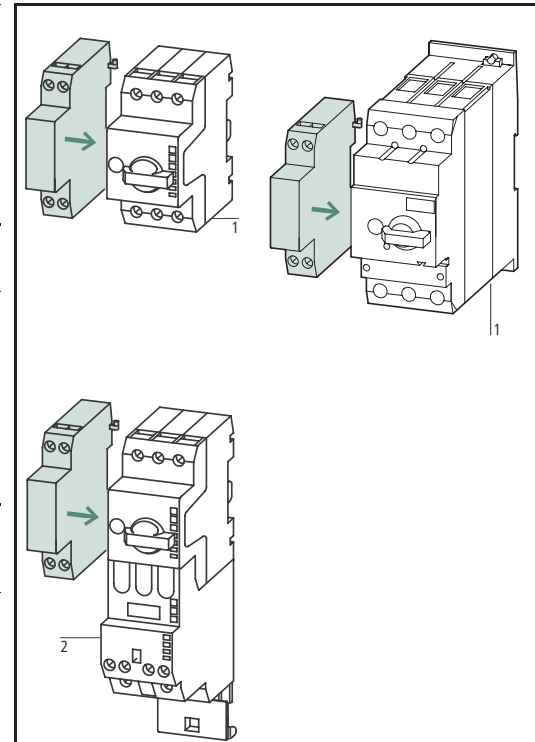

Accessories	Page
1 Motor-protective circuit-breakers	a 8/8
2 Compact starters, (high-capacity) compact starters	a 8/57
Further actuating voltages	a 8/57

Motor-protective circuit-breakers

Motor-protective circuit-breakers



Moeller HPL0211-2004/2005

Max. motor rating AC-3				Auxiliary contacts M = Make B = Break		For use with
220 V	380 V	440 V	500 V			
230 V	400 V			1 M	1 B	
240 V	415 V			2 M		
P	P	P	P			
kW	kW	kW	kW			

Contact module

AC or DC operated

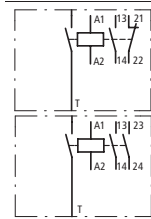
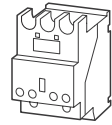

	2.2	4	4	4	1 M	1 B	PKZM0
	2.2	4	4	4	1 M	1 B	
	2.2	4	4	4	2 M		
	2.2	4	4	4	2 M		

High-capacity contact modules, with current limiting contact system

AC or DC operated

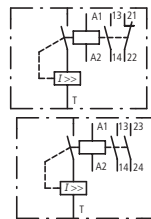
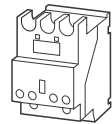

	2.2	4	4	4	1 M	1 B	PKZM0
	2.2	4	4	4	1 M	1 B	
	2.2	4	4	4	2 M		
	2.2	4	4	4	2 M		

Suppressor for (high-capacity) contact modules in AC version

RC suppressor

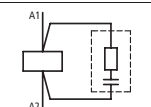
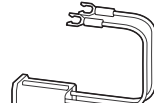

24 – 48 V AC							S(E)00-...-PKZ0(...)
110 – 250 V AC							S(E)00-...-PKZ0(...)

Varistor suppressor

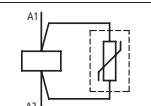

24 – 48 V AC							S(E)00-...-PKZ0
110 – 250 V AC							
380 – 415 V AC							

Base for separate mounting of the (high-capacity) contact module

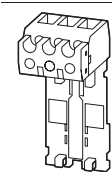

							S(E)00-PKZ0(...) HI11-S/EZ-PKZ0
--	--	--	--	--	--	--	------------------------------------

Mechanical interlock

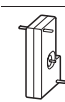

							S(E)00-PKZ0(...)
--	--	--	--	--	--	--	------------------

Auxiliary contacts for (high-capacity) contact module

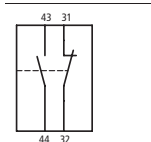
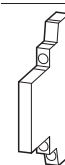

					1 M	1 B	
--	--	--	--	--	-----	-----	--





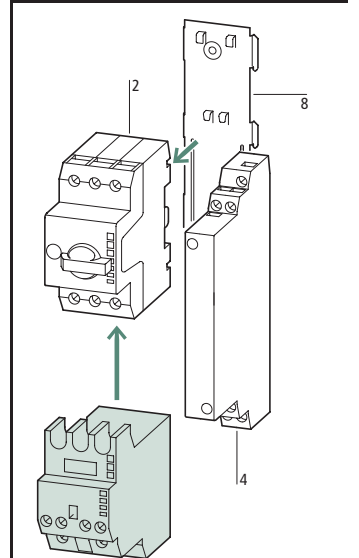



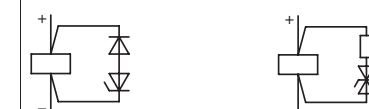

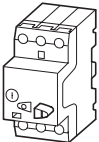

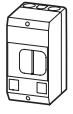
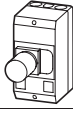

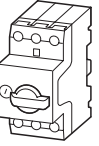
Moeller HPL0211-2004/2005

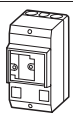
Type Article no.	Price See Price List	Std. pack	Notes
SE00-11-PKZ0(230V50HZ,240V60HZ) 063321		1 off	Contact module can be fitted to motor-protective circuit-breaker, profiles match.
SE00-11-PKZ0(24VDC) 072823			Clip plate for snap-fitting the combination must be ordered separately (required as standard).
SE00-20-PKZ0(230V50HZ,240V60HZ) 063329			Can be used in reversing starter combinations by the addition of a mechanical interlock.
SE00-20-PKZ0(24VDC) 072817			Contact module for separate mounting. Can be snap-fitted to IEC/EN 60715 top-hat rail with 7.5 or 15 mm height.
S00-11-PKZ0(230V50HZ,240V60HZ) 063338		1 off	High-capacity contact module can be fitted to motor-protective circuit-breaker, profiles match.
S00-11-PKZ0(24VDC) 072747			Clip plate for snap-fitting the combination must be ordered separately (required as standard).
S00-20-PKZ0(230V50HZ,240V60HZ) 063347			Can be used in reversing starter combinations by the addition of a mechanical interlock.
S00-20-PKZ0(24VDC) 072741			High-capacity contact module for separate mounting. Can be snap-fitted to IEC/EN 60715 top-hat rail with 7.5 or 15 mm height.
RCSPKZ048 063976		10 off	(High-capacity) contact module, DC version: Suppressor is fitted as standard 12 V DC, 24 V DC, 48 V DC 110 V DC, 220 V DC and 60 V DC
RCSPKZ0250 063975			
VGSPKZ48 063974			
VGSPKZ250 063973			
VGSPKZ415 063972			
EZ-PKZ0 072901		1 off	For retrofitting the (high-capacity) contact module as a stand-alone switching device. Can be snap-fitted to the IEC/EN 60715 top-hat rail, height 7.5 or 15 mm.
MV-PKZ0 072892		2 off	For mechanically interlocking two separately mounted (high-capacity) contact modules or two (high-capacity) compact starters.
HI11-S/EZ-PKZ0 072893		5 off	Cannot be combined with NHI...-PKZ0 or AGM...-PKZ0.

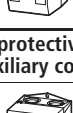

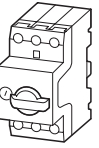
Accessories	Page
2 Motor-protective circuit-breakers	a 8/8
4 Standard auxiliary contact	a 8/14
8 Clip plate	a 8/24
Further actuating voltages	a 8/57

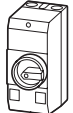

Enclosure		Accessories										
Type	Type	Degree of protection	Handle colour	NHI...-PKZO	AGM2...-PKZO	NHI-E...-PKZO	VHI...-PKZO	VHI...-PKZO1	U-PKZO or A-PKZO	L-PKZO		
Surface mounting enclosure												
PKZM01 motor-protective circuit-breakers												
		CI-PKZ01	IP40	-	-	-	●	-	-	●	●	
					-	-	-	-	●	●	●	
	CI-PKZ01-G	IP65	-	-	-	●	-	-	●	●	●	
				●	-	●	-	-	●	●	●	
	CI-PKZ01-PVT CI-PKZ01-PVS	IP65	Red-yellow	-	-	●	-	-	●	●	●	
				-	-	-	-	●	●	●		
	CI-PKZ01-SVB	IP65	-	-	-	●	-	-	●	●	●	
				-	-	-	-	-	●	●		
	CI-PKZ01-SVB-V	IP65	-	-	-	-	-	K ¹⁾	●	●	●	
PKZM0 motor-protective circuit-breakers												
		CI-K2-PKZ0	IP41	-	●	-	●	-	-	●	●	
					-	●	●	-	-	●	●	
	CI-K2-PKZ0-G	IP65	Black	●	-	●	-	-	●	●	●	
				-	●	●	-	-	●	●		
	CI-K2-PKZ0-GR	IP65	Red-yellow	●	-	●	-	-	●	●	●	
				-	●	●	-	-	●	●		
	CI-PKZ0-M	IP40	-	●	-	●	-	-	-	●	●	
				-	-	●	-	-	●	●		
	CI-PKZ0-GM	IP55	Black	●	-	●	-	-	-	●	●	
				-	-	●	-	-	●	●		
	CI-PKZ0-GRM	IP55	Red-yellow	●	-	●	-	-	-	●	●	
				-	-	●	-	-	●	●		
PKZM0 motor-protective circuit-breakers + early-make auxiliary contact VHI-PKZO												
		CI-K2-PKZ0-GV	IP65	Black	●	-	-	●	-	●	●	
					-	●	-	●	-	●	●	
	CI-K2-PKZ0-GRV	IP65	Red-yellow	●	-	-	●	-	●	●	●	
				-	●	-	●	-	●	●		
	CI-K2-PKZ0-GVM	IP55	Black	●	-	-	●	-	-	●	●	
				-	-	-	●	-	●	●		
	CI-K2-PKZ0-GRVM	IP55	Red-yellow	●	-	-	●	-	-	●	●	
				-	-	-	●	-	●	●		

Notes

The combination possibilities of circuit-breakers in an enclosure with accessory modules are identified by a ●
¹⁾ always necessary

Accessories for motor-protective circuit-breaker in enclosure



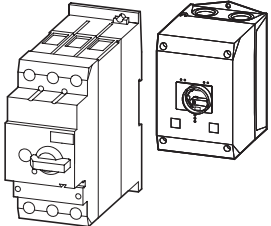
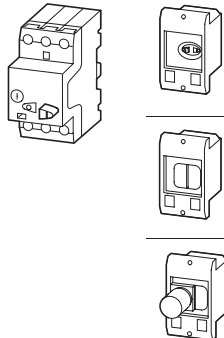
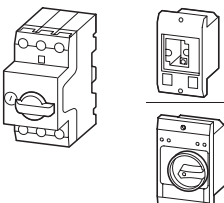







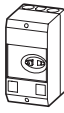
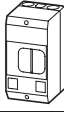



Moeller HPL0211-2004/2005

Enclosure					Accessories						
Type	Type	Degree of protection	Handle colour	NHI...-PKZ0	AGM2...-PKZ0	NHI-E...-PKZ0	VHI...-PKZ0	VHI...-PKZ01	U-PKZ0 or A-PKZ0	L-PKZ0	
Surface mounting enclosure											
PKZM4 motor-protective circuit-breakers											
	CI-K4-PKZ4-G	IP65	Black	●	●	●	-	-	●	●	
	CI-K4-PKZ4-GR	IP65	Red-yellow	●	●	●	-	-	●	●	
				●	●	-	●	-	●	●	
				●	●	-	●	-	●	●	
Installation enclosure											
PKZM01 motor-protective circuit-breakers											
	E-PKZ01	IP40	-	-	-	●	-	-	●	●	
				-	-	-	-	●	●	●	
				●	-	●	-	-	-	●	
	E-PKZ01-G	IP55	-	-	-	●	-	-	●	●	
				-	-	-	-	●	●	●	
				●	-	●	-	-	●	-	●
	E-PKZ01-PVT E-PKZ01-PVS	IP55	Red-yellow	-	-	●	-	-	●	●	
				-	-	-	-	●	●	●	
	E-PKZ01-SVB	IP55	-	-	-	●	-	-	●	●	
				-	-	-	-	-	●	●	
	E-PKZ01-SVB-V	IP55	-	-	-	-	-	⋈ ¹⁾	●	●	
				-	-	-	-	-	●	●	
PKZM0 motor-protective circuit-breakers											
	E-PKZ0	IP40	-	●	-	-	-	-	-	●	
				-	-	-	-	-	●	●	
				●	-	●	-	-	-	●	
				-	-	●	-	-	●	●	
	E-PKZ0-G	IP55	Black	●	-	●	-	-	-	●	
				-	-	●	-	-	●	●	
	E-PKZ01-GR	IP55	Red-yellow	●	-	●	-	-	-	●	
				-	-	●	-	-	●	●	

Notes

The combination possibilities of circuit-breakers in an enclosure with accessory modules are identified by a ●
¹⁾ always necessary









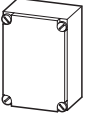

	Degree of protection	For use with	Type Article no.	Price See Price List	Std. pack	
Insulated enclosures for surface mounting						
For PKZM01 motor-protective circuit-breakers						
		IP40	PKZM01 +NHI-E or VHI-PKZ01 +U or A or NHI	CI-PKZ01 281403	2 off	Integrated terminal for PE(N) connection, two M25 cable entry knockouts at top and at bottom.
	With actuation membrane	IP65	PKZM01 +NHI-E or VHI-PKZ01 +U or A or NHI	CI-PKZ01-G 281404	2 off	
	Lockable in off position		PKZM01 +NHI-E +U or A (undervoltage or shunt release) +L (2 off)	CI-PKZ01-SVB¹⁾ 281405	2 off	
	Lockable in off position in combination with VHI-PKZ01		PKZM01 +NHI-E or VHI-PKZ01 +U or A (undervoltage or shunt release) +L (2 off)	CI-PKZ01-SVB-V¹⁾ 281944	1 off	
	With Emergency-Stop push button actuator, stay-put With Emergency-Stop push button actuator, release with key		PKZM01 +NHI-E +U or A (undervoltage or shunt release) +L (2 off)	CI-PKZ01-PVT¹⁾ 281406 CI-PKZ01-PVS¹⁾ 281407	2 off 2 off	
For PKZM0 motor-protective circuit-breakers						
	Cover with aperture dimensioned to accommodate front of breaker. IP40, when mounted turned through 90° to left/right	IP41 with vertical mounting	PKZM0-... +NHI or AGM +U or A (undervoltage or shunt release) +NHI-E +L-PKZ0 (2 off)	CI-K2-PKZ0 219653	1 off	M25 metric cable entry knockout, top and bottom Cable push-through membrane top, bottom, in the back plate and as a control line entry. CI-K2 insulated enclosure incl. N and PE terminal.
	With black/grey rotary handle	IP65		CI-K2-PKZ0-G 219654		
	With red/yellow rotary handle for use as Emergency-Stop switches to IEC/EN 60204	IP65		CI-K2-PKZ0-GR 219655		
	Cover with aperture dimensioned to accommodate front of breaker	IP40	PKZM0-... +NHI or U or A +L-PKZ0 (2 off)	CI-PKZ0-M 267083		Integrated terminal for PE(N) connection, two M25 cable entry knockouts at top and at bottom.
	With black/grey rotary handle	IP55	PKZM0-... +NHI-E +NHI or U or A +L-PKZ0 (2 off)	CI-PKZ0-GM 260089 CI-PKZ0-GRM 260104	2 off 2 off	
For PKZM0 motor-protective circuit-breakers with VHI early-make auxiliary contacts						
	With black/grey rotary handle	IP65	PKZM0-... and VHI +NHI or AGM +U or A (undervoltage or shunt release) +L (2 off)	CI-K2-PKZ0-GV 219657	1 off	M25 metric cable entry knockout, top and bottom Cable push-through membrane top, bottom, in the back plate and as a control line entry. CI-K2 insulated enclosure incl. N and PE terminal.
	With red/yellow rotary handle for use as Emergency-Stop switches to IEC/EN 60204	IP65		CI-K2-PKZ0-GRV 219656	1 off	
	With black/grey rotary handle	IP55	PKZM0-... and VHI +U or A (undervoltage or shunt release) +L-PKZ0 (2 off)	CI-PKZ0-GVM 263526 CI-PKZ0-GRVM 263525	2 off 2 off	Integrated terminal for PE(N) connection, two M25 cable entry knockouts at top and at bottom.
	With red/yellow rotary handle for use as Emergency-Stop switches to IEC/EN 60204	IP55				
For PKZM4 motor-protective circuit-breakers						
	With black/grey rotary handle	IP65	PKZM4-... +VHI or NHI-E +NHI and AGM +U or A (undervoltage or shunt release) +L-PKZ0 (2 off)	CI-K4-PKZ4-G 225524 CI-K4-PKZ4-GR 225525	1 off 1 off	Metric knockout: Top and bottom: M25/M32 in the back plate: M25/M32 Control cable entry: M20 CI-K4 insulated enclosure including insulated PE terminal

Notes





¹⁾ Availability on request.

Moeller HPL0211-2004/2005

	Degree of protection	For use with	Type Article no.	Price See Price List	Std. pack	
	Padlocking feature For up to 3 padlocks with 3 – 6 mm hasp thickness, for use as main switch to IEC/EN 60204	CI-K2-PKZ0-G(R)(V) CI-PKZ0-G(R)(V)M	SVB-PKZ0-CI 035129		3 off	Lockable in the 0-position of the PKZM0 or PKZM4 motor-protective circuit-breaker.
		CI-K4-PKZ4-G(R)	SVB-PKZ4-CI 225526		1 off	
		IP65 PKZM0-.../S(E)00 +NHI or NHI...S +NHI-E +U or A (undervoltage or shunt release) +R(H) +L-PKZ0 (2 off)	CI23E-125 019570		1 off	For (high-capacity) compact starters R(H)-PKZ0 (IP65) door coupling handle can be installed Mounting depth 125 mm Additional mounting plate M3-CI23 required
Neutral terminals For connection of a 5th conductor						
	flexible, 1 – 4 mm ²	–	CI-K2-PKZ0-...	K-CI-K1/2 207451	20 off	–
	63 A, flexible, 6 – 16 mm ²	–	CI-K4-PKZ4-G(R)	K25/1 096200	10 off	–
Insulated enclosures for flush mounting						
For PKZM01 motor-protective circuit-breakers						
	–	Front IP40	PKZM01 +NHI-E or VHI-PKZ01 +U or A or NHI +L (2 off)	E-PKZ01 281633	1 off	Integrated terminal for PE(N) connection.
	With actuation membrane	Front IP55	PKZM01 +NHI-E +U or A (undervoltage or shunt release) +L (2 off)	E-PKZ01-G 281634		
	Lockable in off position		PKZM01 +NHI-E +U or A (undervoltage or shunt release) +L (2 off)	E-PKZ01-SVB¹⁾ 281635		
	Lockable in off position in combination with VHI-PKZ01		PKZM01 +NHI-E or VHI-PKZ01 +U or A (undervoltage or shunt release) +L (2 off)	E-PKZ01-SVB-V¹⁾ 281943		
	With Emergency-Stop push button actuator, stay-put With Emergency-Stop push button actuator, release with key		PKZM01 +NHI-E or VHI-PKZ01 +U or A (undervoltage or shunt release) +L (2 off)	E-PKZ01-PVT¹⁾ 281636 E-PKZ01-PVS¹⁾ 281637		
For PKZM0 motor-protective circuit-breakers						
	Cover with aperture dimensioned to accommodate front of breaker	Front IP40	PKZM0-... +NHI or U or A +L-PKZ0 (2 off)	E-PKZ0 072906	1 off	Integrated terminal for PE(N) connection.
	With black/grey rotary handle	Front IP55	PKZM0-... +NHI or U or A	E-PKZ0-G 072907		
	With red/yellow rotary handle for use as Emergency-Stop switches to IEC/EN 60204	Front IP55	PKZM0-... +NHI-E +L-PKZ0 (2 off)	E-PKZ0-GR 072908		
	Padlocking feature For up to 3 padlocks with 3 – 6 mm hasp thickness, for use as main switch to IEC/EN 60204		E-PKZ0-G(R)	SVB-PKZ0-E 035127	3 off	Lockable in the OFF position of the PKZM0 motor-protective circuit-breaker
Neutral terminal For connection of a 5th conductor						
			E-PKZ0(-G)(-GR) E-PKZ01(-G)	N-PKZ0 082160	20 off	–

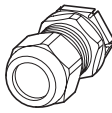
Notes ¹⁾ Availability on request.





	Cable entry	Diameter of drilled hole	External cable diameter	Type Article no.	Price See Price List	Std. pack
		mm	mm			
Metric cable glands, to EN 50262						
	<ul style="list-style-type: none"> • With lock nut and built-in strain relief • IP68 up to 5 bar, halogen free 					
	M20	20.5	6 – 13	V-M20 206910		20 off
	M25	25.5	9 – 17	V-M25 206911		20 off
	M32	32.5	13 – 21	V-M32 206912		10 off
	M32	32.5	18 – 25	V-M32G 226156		10 off
Metric diaphragm grommets						
	<ul style="list-style-type: none"> • IP65 • With integral push-through diaphragm 					
	M20	20.5	1 – 13	KT-M20 207602		100 off
	M25	25.5	1 – 18	KT-M25 207603		
	M32	32.5	1 – 24	KT-M32 207604		
			Colour	Type Article no.	Price See Price List	Std. pack
Clip plates						
	For use with PKZM0 only					
	For (high-capacity) compact starters (required as standard)			C-PKZ0 072900		10 off
	For (high-capacity) compact starter, shortened version			C-PKZ0-K 206740		10 off
IP65 door coupling handle¹⁾						
	For use as main switch to IEC/EN 60204		Black	H-PKZ0 056320		1 off
	For use as a main switch with Emergency-Stop function, to EN 60204		Red-yellow	RH-PKZ0 056321		
	For use as a main switch to EN 60204 in MCC power distribution systems and with PKZM0 installed when rotated by 90°		Black	H-PKZ0-MCC 201454		
	For use as a main switch with Emergency-Stop function to EN 60204 in MCC power distribution systems and with PKZM0 installed when rotated by 90°		Red-yellow	RH-PKZ0-MCC 201455		
	For simple external actuation, without door interlock and locking facility		Black	HSOV-PKZ0 203598		
						<p>Plug-in extension shaft A-H-PKZ0 can be cut to desired length for mounting depths of 100 – 240 mm. Carrier with extension shaft included in delivery. With ON/OFF switch position and "+" (tripped), lockable with 3 padlocks, 4 – 8 mm hasp. Preparation for locking facility in ON.</p> <p>Plug-in extension shaft A-H-PKZ0 can be cut to desired length for mounting depths of 100 – 240 mm. Carrier with extension shaft included in delivery.</p>

Notes



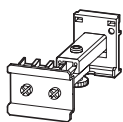





¹⁾ Additional front labels:
ZFS...-T0 or ZFS...-P3
17 × 48 mm or 27 × 88 mm a 7/48
and ZFS60-NZM7
For use with 17 × 64 mm a 10/134

Moeller HPL0211-2004/2005



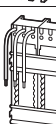



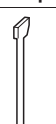





	Type Article no.	Price See Price List	Std. pack	
Telescopic adapter				
With 45 mm top-hat rail to IEC/EN 60715 for compensation of the mounting depth of rear mounted devices in CI-K... enclosures and cabinets				
	For PKZM0, PKZM01 motor-protective circuit-breakers	M22-TA 226161	1 off	Stepless adjustment via scale from 75 – 115 mm.
Lockable rotary handle				
	For locking the motor-protective circuit-breaker from serial no. 01 or (high-capacity) compact starter as a main switch to EN 60204. Can be padlocked in the "0" position with a padlock. Hasp thickness: 3 – 6.35 mm	AK-PKZO 030851	5 off	–
Sealing facility				
	To prevent tampering with the overload release and the test function, it can be sealed using industry standard sealing wire For use with motor-protective circuit-breakers from serial no. 02 (PKZM0)	PL-PKZO 203599	5 off	–
Documentation				
	PKZM0 motor-protective circuit-breakers, overload monitoring of EEx e motors	AWB1210-1458D/GB 266164	1 off	German/English
	PKZM4 motor-protective circuit-breakers, overload monitoring of EEx e motors	AWB1210-1457D/GB 266165	1 off	German/English

	Colour	Voltage V	Type Article no.	Price See Price List	Std. pack	
Indicator lights with neon bulb						
	White	110 – 230	L-PKZO(230V) 082151		10 off	–
		230 – 400	L-PKZO(400V) 082152			–
		415 – 500	L-PKZO(500V) 082153			–
	Green	110 – 230	L-PKZO-GN(230V) 082154		5 off	–
		230 – 400	L-PKZO-GN(400V) 082155			–
		415 – 500	L-PKZO-GN(500V) 082156			–
	Red	110 – 230	L-PKZO-RT(230V) 082157		10 off	–
		230 – 400	L-PKZO-RT(400V) 082158			–
		415 – 500	L-PKZO-RT(500V) 082159			–





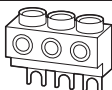

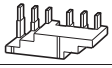
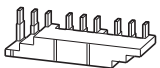

	Rated operational voltage U_e V	Rated operational current I_e A	Adapter width mm	For use with	Type Article no.	Price See Price List	Std. pack	
Component adapter, 3-pole								
For mounting on flat copper busbars 20 × 5 mm and 30 × 5 mm and Cu profiled busbars 800 A with 60 mm interval between busbar centres								
	690	25	54	PKZM0-... PKZM0-.../S(E)00 +AGM or NHI	AD25/5-1 025395		1 off	Mounted by latching onto de-energized busbar SASY60 busbar adaptation system
			108	PKZM0-... +2 × DILE+MVDILE or +2 × DILO(0)AM+MVDILM or +2 × EZ-PKZ0+MV-PKZ0	AD25/5-2 025397			
			144	PKZM0-... +2 × EZ-PKZ0+MV-PKZ0+HI11-S	AD25/5-144 025399			
		63	72	PKZM4-... +AGM and +NHI	AD63/5-1 232149			
For mounting on flat copper busbars 30 × 10 mm and Cu profiled busbars 1600 A with 60 mm interval between busbar centres								
	690	25	54	PKZM0-... PKZM0-.../S(E)00 +AGM or NHI	AD25/10-1 025396		1 off	Mounted by latching onto de-energized busbar
			108	PKZM0-... +2 × DILE+MVDILE or +2 × DILO(0)AM+MVDILM or +2 × EZ-PKZ0+MV-PKZ0	AD25/10-2 025398			
			144	PKZM0-... +2 × EZ-PKZ0+MV-PKZ0+HI11-S	AD25/10-144 025400			
		63	72	PKZM4-... +AGM and +NHI	AD63/10-1 232148			
For mounting on flat copper busbars 12 × 5 mm with 40 and 50 mm interval between busbar centres								
	690	32	54	PKZM0	SP-PKZ0 202354		2 off	-
			54	PKZM0-.../S(E)00	SP-PKZ0/S 206739			
			45	PKZM0	SP-32/45-PKZ0 208655			
Adapter extension								
	-	-	9	-	AD-E 060511		1 off	Can be fitted onto AD... to extend mounting width

Moeller HPL0211-2004/2005

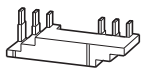
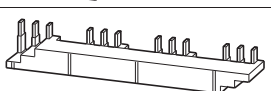

Circuit-breaker/ compact starter	Length mm	Unit width mm	Type Article no.	Price See Price	Std. pack
Quantity	mm	mm			
Three-phase commoning link					
Protected against accidental contact, short-circuit proof $U_e = 690\text{ V}$, $I_u = 63\text{ A}$ Can be extended turned installation					
For PKZM0-... or PKZM0-..S(E)00 without side mounted auxiliary contact or voltage release					
	2	90	45	B3.0/2-PKZO 063961	10 off
	3	135		B3.0/3-PKZO 232289	–
	4	180		B3.0/4-PKZO 063960	–
	5	225		B3.0/5-PKZO 232290	–
For motor-protective circuit-breakers/(high-capacity) compact starters each having one auxiliary contact or trip-indicating auxiliary contact fitted on the right.					
	2	99	45 + 9	B3.1/2-PKZO 044945	10 off
	3	153		B3.1/3-PKZO 044946	–
	4	207		B3.1/4-PKZO 044947	–
	5	261		B3.1/5-PKZO 044948	–
For PKZM0-... or PKZM0-..S(E)00 each with an auxiliary contact and a trip-indicating auxiliary contact mounted on the right or a voltage release mounted on the left or for (high-capacity) compact starter with a long NH12-11S-PKZO standard auxiliary contact mounted on the right					
	2	108	45 + 18	B3.2/2-PKZO 063963	10 off
	4	234	45 + 18	B3.2/4-PKZO 063959	10 off
Shroud for unused terminals					
Protection against direct contact. To cover unused terminals on three-phase commoning link					
	–	–	–	H-B3-PKZO 032721	20 off
Incoming terminal					
	–	–	–	BK25/3-PKZO 032720	5 off
For three-phase commoning link, protected against accidental contact, $U_e = 690\text{ V}$, $I_u = 63\text{ A}$ For conductor cross-sections: 2.5 – 25 mm ² stranded 2.5 – 16 mm ² flexible with ferrules					
Blade terminal to DIN 46244					
For connecting insulated ferrules for: Main cable up to 25 A, 1 × 6.3 mm (DIN 46245) Control circuit cable up to 6 A, 2 × 2.8 mm (DIN 46247)					
	–	–	–	BT483 059904	100 off
Use insulated ferrules to DIN 46245.					



	Circuit-breaker/ compact starter	Length	Unit width	Type Article no.	Price See Price List	Std. pack
	Quantity	mm	mm			
Three-phase commoning link						
Protected against accidental contact, short-circuit proof $U_e = 690\text{ V}$, $I_u = 128\text{ A}$						
For PKZM4 without side mounted auxiliary contact or voltage release						
	2	110	55	B3.0/2-PKZ4 220220		1 off
	3	165		B3.0/3-PKZ4 220221		
	4	220		B3.0/4-PKZ4 220222		
For PKZM4 each with an auxiliary contact or trip-indicating auxiliary contact fitted on the right or with a DIL1(A)M contactor						
	2	119	55 + 9	B3.1/2-PKZ4 220223		1 off
	3	183		B3.1/3-PKZ4 220224		
	4	247		B3.1/4-PKZ4 220225		
For PKZM4 each with an auxiliary contact or trip-indicating auxiliary contact fitted on the right or with a voltage release fitted on the left or with a DIL2(A)M contactor						
	2	128	55 + 18	B3.2/2-PKZ4 220226		1 off
	4	274		B3.2/4-PKZ4 220227		
Shroud for unused terminals						
Protection against direct contact. To cover unused terminals on three-phase commoning link						
	-	-	-	H-B3-PKZ4 220228		10 off

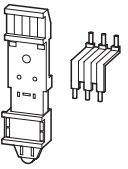
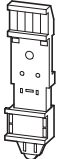
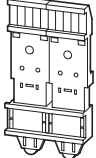
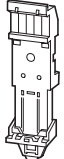

Moeller HPL0211-2004/2005

For use with	Type Article no.	Price	Std. pack	
MVS kits for direct-on-line starters				
	PKZ0+DILE(E)M(-G)	MVS-D0-EM 220230	1 off	For the following components: PKZM0 motor-protective circuit-breaker and DILM contactor.
	PKZ0+DIL00(A)M (AC operated)	MVS-D5 038683		
	PKZ0+DIL0(A)M (AC operated)	MVS-D11 031166		
Top-hat rail adapter for motor-starter combinations				
	—	MVS-C45 202319	8 off	Top-hat rail adapter, 45 mm wide, includes connection lug for expansion using MVS-D as reversing starter.
	—	MVS-C90H 201491	12 off	Top-hat rail adapter 90 mm wide with continuous top-hat rail at top and bottom. For expansion of the MVS-D... as a star-delta switch.
Top-hat rail adapter for (high-capacity) compact starters				
	Direct-on-line starter PKZM0-.../S(E)00-PKZ0	MVS-C45-S 203204	24 off	For use of (high-capacity) compact starters in conjunction with other starters on MVS mounting plates. Parallel feed possible via three-phase commoning links
Top-hat rail extension for top-hat rail adapter				
	For all MVS-C...	MVS-H15 215554	10 off	To allow for a wider mounting plate for reversing starters with mechanical interlock
Link between motor-protective circuit-breaker and contactor				
	PKZM0+DILE(E)M(-G)	MVS-LBM0-EM 220219	1 off	To electrically and mechanically link the PKZM0 motor-protective circuit-breaker and DILE(E)M contactors. For use with and without MVS-C45
	PKZM0+DILE(E)M(-G)-C PKZM0+DIL00(A)M-C	MVS-LB14/140 229295	10 off	Flexible link between PKZM0 and DILM contactor AWG14, length 140 mm
	PKZM0+DIL00(A)M-G	MVS-LB0-00M-G 226149		Flexible link between PKZM0 and DILM contactor AWG12, length 110 mm
	PKZM0+DIL0(A)M-G	MVS-LB0-0M-G 226150		Flexible link between PKZM0 and DILM contactor AWG10; length 120 mm

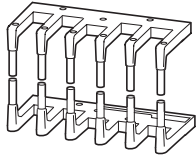
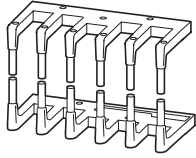
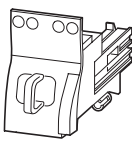
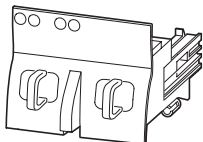

For use with	Type Article no.	Price See Price	Std. pack
Reversing starter wiring kits			
Main current wiring for reversing combinations			
	DILE(E)M (+MVDILEM)	MVS-WB-EM 220209	1 off The following control cables are integrated in addition to electrical interlock: <ul style="list-style-type: none">• K1M: A1 – K2M: 21• K1M: 21 – K2M: A1• K1M: A2 – K2M: A2 For use with overload relay separate mounting. <hr/> The following connection is also integrated: <ul style="list-style-type: none">• K1M: A2 – K2M: A2 For use with overload relay separate mounting.
	DIL00(A)M	MVS-WB-00M 220210	
	DIL00(A)M+MVDILM	MVS-WB5MV 215512	
	DIL0(A)M	MVS-WB-0M 220211	
	DIL0(A)M+MVDILM	MVS-WB11MV 216344	
	DIL1(A)M	MVS-WB-1M 220212	
Star-delta wiring kits			
Main current wiring for star-delta combination incl. star-point bridge			
	DILE(E)M mains contactor DILE(E)M delta contactor DILE(E)M star contactor	MVS-SB-EM 220213	1 off The following control cables are integrated in addition to electrical interlock: <ul style="list-style-type: none">• K3M: A1 – K5M: 21• K3M: 21 – K5M: A1• K3M: A2 – K5M: A2 For use with overload relay separate mounting. <hr/> For use with overload relay separate mounting.
	DIL00(A)M mains contactor DIL00(A)M delta contactor DIL00(A)M star contactor	MVS-SB-00M 220214	
	DIL0(A)M mains contactor DIL0(A)M delta contactor DIL00(A)M star contactor	MVS-SB-0M 220215	
	DIL0(A)M mains contactor DIL0(A)M delta contactor DIL0(A)M star contactor	MVS-SB-0AM 220216	
	DIL1(A)M mains contactor DIL1(A)M delta contactor DIL0(A)M star contactor	MVS-SB-1M 220217	
Wiring kit¹⁾			
	PKZM0+DILM7 PKZM0+DILM9 PKZM0+DILM12	PKZM0-XDM12 283149	1 off Comprised of: <ul style="list-style-type: none">• Mechanical connection element for PKZM0 and contactor• Main current wiring between PKZM0 and contactor in tool-less plug connection <hr/> Comprised of: <ul style="list-style-type: none">• Top-hat rail adapter plate• Main current wiring between PKZM0 and contactor
	PKZM0+DILM17 PKZM0+DILM25 PKZM0+DILM32	PKZM0-XDM32 283153	
	PKZM0+DILM7-01 PKZM0+DILM9-01 PKZM0+DILM12-01	PKZM0-XRM12 283185	
	PKZM0+DILM17 PKZM0+DILM25 PKZM0+DILM32	PKZM0-XRM32 283189	Comprised of: <ul style="list-style-type: none">• Top-hat rail adapter plate• Reversing starter main current wiring
Top-hat rail adapter plate¹⁾			
Top-hat rail adapter plate	PKZM0-XDM12 PKZM0-XRM12	PKZM0-XC45 283132	3 off Comprised of: <ul style="list-style-type: none">• 45 mm wide adapter plate• Connection elements for side-by-side positioning of further plates

Moeller HPL0211-2004/2005

	MVS-D0-EM	D5	D11	MVS-C45	MVS-LB0-00M-G	0M-G
PKZM0+DIL... direct-on-line starter						
DILE(E)M(-G)	K					
DIL00(A)M		K				
DIL00(A)M-G				K	K	
DILO(A)M			K			
DILO(A)M-G				K		K

	MVS-D0-EM	D5	D11	MVS-C45	C90H	MVS-LB0-00M-G	0M-G	MVS-WB-EM	00M	0M
PKZM0+DIL... reversing starter without mechanical interlock										
DILE(E)M(-G)	K			K				K		
DIL00(A)M		K		K					K	
DIL00(A)M-G					K	K			K	
DILO(A)M			K	K						K
DILO(A)M-G					K		K			K

	MVS-D0-EM	D5	D11	MVS-C45	C90H	MVS-H15	MVS-LB0-00M-G	0M-G	MVS-WB...-EM	5MV	11MV
PKZM0+DIL... reversing starter with mechanical interlock											
DILE(E)M(-G)	K			K					K		
DIL00(A)M		K		K		K				K	
DIL00(A)M-G					K	K	K			K	
DILO(A)M			K	K		K					K
DILO(A)M-G					K	K		K			K

	MVS-D0-EM	D5	D11	MVS-C45	C90H	MVS-LB0-00M-G	0M-G	MVS-SB-EM	00M	0M
PKZM0+DIL... star-delta switch (mains contactor)										
DILE(E)M(-G)	K				K			K		
DIL00(A)M		K			K				K	
DIL00(A)M-G				K	K	K			K	
DILO(A)M			K		K					K
DILO(A)M-G				K	K		K			K



Motor protection, system protection, line and cable protection

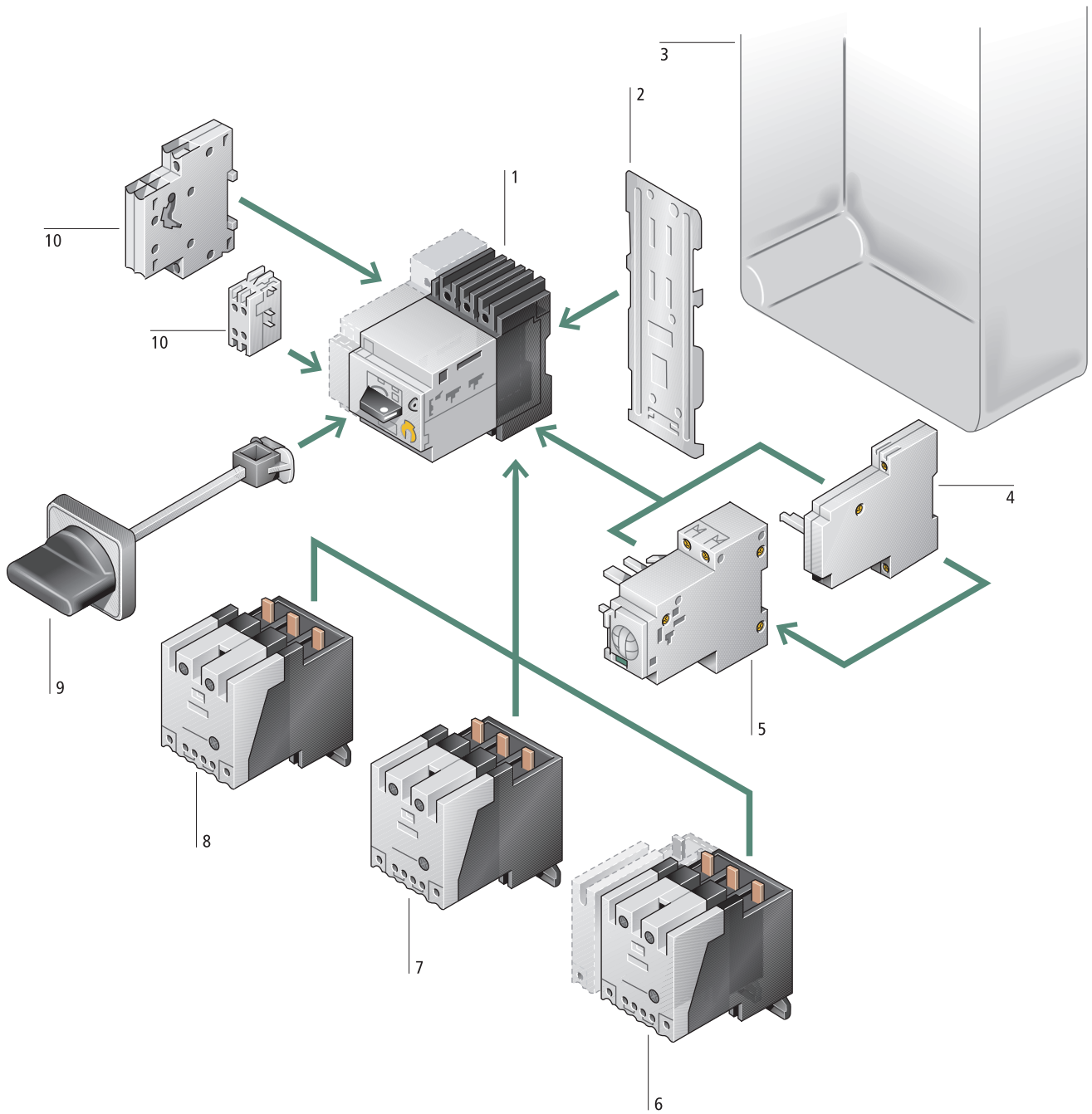

Moeller HPL0211-2004/2005

Basic units	Add-on functions	
Motor-protective circuit-breakers 1	Contact module 6	Remote operators 5
Rated operational current 40 A 18.5 kW/415 V	Function and characteristics of a contactor	Remote ON/OFF motor-protective circuit- breaker
Switching capacity 30 kA/415 V	When fitted to a motor-protective circuit- breaker a classification type "1" compact starter is the result	Remote reset for ON/OFF motor-protective circuit-breaker
Overload releases, adjustable	Can be fitted to 3 and 4-pole circuit- breakers with matched profiles	AC and DC voltages
Short-circuit release, adjustable	Integrated auxiliary contact 1 M, 1B or 2 M	Manual/Auto operation
Single-phasing sensitive	Can be mounted separately, e.g. for use in reversing starters	Manual/Auto signalling contact
Thumb-grip lockable by means of a padlock (4 – 6 mm \varnothing)	SE1A-G-10-PKZ2 contact module for 24 V DC	RS-PKZ2 remote operator is suitable for direct 24 V DC actuation from a PLC
ZMR control unit with overload relay function		a 8/49
Fingerproof terminals		
a 8/37	a 8/51	
		Mounting accessories
Circuit-breakers 1	High-capacity contact module 7	Mounting/wiring 2
Rated operational current up to 40 A	As for contact module	Clip plate can be snap fitted to the IEC/EN 60715 top-hat rails
Switching capacity 30 kA/415 V	Increases the switching capacity to $I_q = 100 \text{ kA}/500 \text{ V}$	With integrated screw fixing
Overload releases, adjustable	When fitted to a motor-protective circuit- breaker a classification type "2" high- capacity compact starter is the result	Three-phase current commoning link for side-by-side mounting of 3 or 2 circuit- breakers
Short-circuit release, adjustable	S-G-PKZ2 high-capacity contact module for actuation with 24 V DC	Component adapter for busbar mounting
Thumb-grip lockable by means of a padlock (4 – 6 mm \varnothing)		Reversing combination with short-circuit proof three phase commoning links
3 and 4-pole design		a 8/55
Fingerproof terminals		
a 8/37		
	Auxiliary contacts 10	Door coupling rotary handle IP65 9
	ON/OFF indication of motor-protective circuit-breaker	ON/OFF/Tripped switch position indication
	Differential fault indication overload/ short-circuit release	Lockable with 3 padlocks
	ON/OFF for (high-capacity) contact module	Integrated door/cover interlock
	ON/OFF for starter combination	Adaption by means of plug-fit extension shaft
	a 8/45	a 8/54
	Current limiter 8	
	Increases the switching capacity to 100 kA/500 V	Insulated enclosures 3
	For separate mounting as group protection	IP40 and IP54 surface mounting enclosure
	a 8/45	IP41 and IP54 front flush mounting enclosure
	Voltage releases 4	a 8/54
	Undervoltage release	
	– with early-make auxiliary contact	
	– off-delayed with early make contacts	
	Shunt release	
	a 8/47	

**Product features**

- Main switch and isolating characteristics
- 3 and 4-pole circuit-breakers with protected neutral pole
- Plug-in trip block
- Visible isolating gap
- Modular system
- Remote operation – motor-protective circuit-breaker
- Differential fault indication via trip-indicating auxiliary contacts
- 3-pole (high-capacity) contact module matched profiles
- 3-pole current limiter matched profiles
- Worldwide approvals

Motor-protective circuit-breakers

Motor-protective circuit-breakers

Enclosure		Modules			
Type	Type	Degree of protection	Standard auxiliary contact NHI11-PKZ2 NHI22-PKZ2	Standard auxiliary contact (H) compact starters NHI11 S-PKZ2 NHI22 S-PKZ2 NHI2-11 S-PKZ2	Trip-indicating auxiliary contact AGM2-11-PKZ2

Remote operator RE-PKZ2 RS-PKZ2	Undervoltage Releases U-PKZ2 UVHI-PKZ2	U-HI20-PKZ2	Shunt release A-PKZ2	Door coupling handle H-PKZ2 RH-PKZ2	Indicator light L-PKZ0
---------------------------------------	--	-------------	-------------------------	---	---------------------------

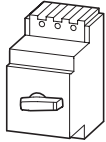
Motor-protective circuit-breaker, circuit-breaker					
PKZ2/ZM-...(-8)					
	Insulated enclosures for flush mounting				
	E-PKZ2	Front IP41	●	-	●
	E 54-PKZ2 door coupling handle R(H)-PKZ 2 is always required as standard	Front IP54	●	-	●
	Insulated enclosures for surface mounting				
	CI19 EA-PKZ2	IP40	●	-	●
	CI19 EB-PKZ2	IP54	●	-	●
Compact starters, high-capacity compact starters					
PKZ2/ZM-.../SE1A/11 PKZ2/ZM-.../S			● or	●	●
	Insulated enclosures for surface mounting				
	CI23 EA-PKZ2	IP40	● or	●	●
	CI23 EB-PKZ 2	IP54	● or	●	●

●	● or	● or	●	-	-
-	-	-	-	-	●
-	● or	● or	●	-	●
-	-	-	-	●	●
-	● or	● or	●	●	●
● or	● or	● or	●	-	-
-	● or	● or	●	●	-
● or	● or	● or	●	-	-
-	● or	● or	●	●	-

Notes The possible combinations of circuit-breakers or (high-capacity) compact starters with enclosures or modules are identified by ●.

Moeller HPL0211-2004/2005

Max. motor rating					Rated uninter- rupted current	Setting range	
AC-3						Overload release	Short-circuit release
220 V	380 V	440 V	500 V	660 V	I_u A	I_r A	I_m A
230 V	400 V			690 V			
240 V	415 V						
<i>P</i>	<i>P</i>	<i>P</i>	<i>P</i>	<i>P</i>			
kW	kW	kW	kW	kW			



Motor-protective circuit-breakers, type "1" and type "2" coordination

0.09	0.12	0.18	0.25	0.25	0.6	0.4 – 0.6	5 – 8
0.12	0.25	0.25	0.37	0.55	1	0.6 – 1	8 – 14
0.25	0.55	0.55	0.75	1.1	1.6	1 – 1.6	14 – 22
0.37	0.75	1.1	1.1	1.5	2.4	1.6 – 2.4	20 – 35
0.75	1.5	1.5	2.2	3	4	2.4 – 4	35 – 55
1.1	2.2	3	3	4	6	4 – 6	50 – 80
2.2	4	4	5.5	7.5	10	6 – 10	80 – 140
4	7.5	9	9	12.5	16	10 – 16	130 – 220
5.5	12.5	12.5	15	22	25	16 – 25	200 – 350
7.5	15	17.5	22	22	32	24 – 32	275 – 425
11	20	22	24	30	40	32 – 40	350 – 500

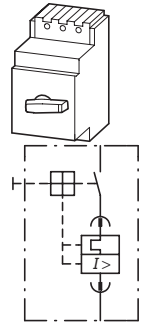

Circuit-breakers

For protection of cables and conductors

-	-	-	-	-	10	6 – 10	50 – 80
-	-	-	-	-	16	10 – 16	80 – 140
-	-	-	-	-	25	16 – 25	130 – 210
-	-	-	-	-	32	24 – 32	160 – 280
-	-	-	-	-	40	32 – 40	200 – 350

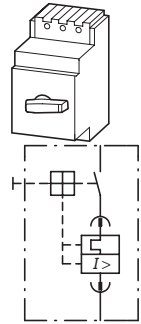

Moeller HPL0211-2004/2005

Type Article no.	Price See Price List	Std. pack	Notes
PKZ2/ZM-0,6 021859		1 off	Single-phasing sensitivity to IEC/EN 60947-4-1, VDE 0660 Part 102 Adjustable overload release $I_r = 0.6 - 1.0 \times I_u$ Adjustable short-circuit release $I_m = 8.5 - 14 \times I_u$ factory set to $12 \times I_u$ Ex PTB 02 ATEX 3152 Observe manual.
PKZ2/ZM-1 026605			
PKZ2/ZM-1,6 028978			
PKZ2/ZM-2,4 031351			
PKZ2/ZM-4 033724			
PKZ2/ZM-6 036097			
PKZ2/ZM-10 038470			
PKZ2/ZM-16 040843			
PKZ2/ZM-25 043216			
PKZ2/ZM-32 045589			
PKZ2/ZM-40 047962			
PKZ2/ZM-10-8 050335		1 off	Adjustable overload release $I_r = 0.6 - 1.0 \times I_u$ Adjustable short-circuit release $I_m = 5.0 - 8.5 \times I_u$ factory set to $5 \times I_u$ Can be snap fitted to IEC/EN 60715 with 7.5 or 15 mm height
PKZ2/ZM-16-8 052708			
PKZ2/ZM-25-8 055081			
PKZ2/ZM-32-8 057454			
PKZ2/ZM-40-8 059827			

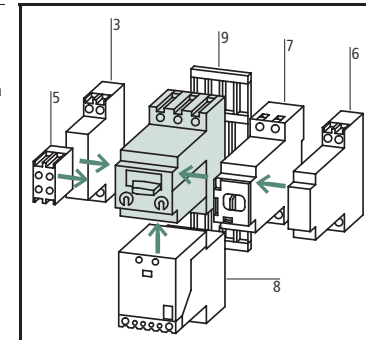

Accessories	Page
3 Standard auxiliary contact	a 8/45
5 Trip-indicating auxiliary contact	a 8/45
6 Shunt release, undervoltage release	a 8/47
7 Remote operators	a 8/49
8 Contact module, high-capacity contact module, current limiter	a 8/51
9 Clip plate	a 8/55
Additional accessories	a 8/54
Rated ultimate short-circuit breaking capacity	a Technical data
Manual	a 8/55

Motor-protective circuit-breakers



Moeller HPL0211-2004/2005

Max. motor rating AC-3					Rated uninterrupted current	Setting range		
220 V	380 V	440 V	500 V	660 V		690 V	Overload release	Short-circuit release
220 V	380 V	440 V	500 V	660 V				
230 V	400 V							
240 V	415 V							
<i>P</i>	<i>P</i>	<i>P</i>	<i>P</i>	<i>P</i>	I_u	I_r	I_{rm}	
kW	kW	kW	kW	kW	A	A	A	



Compact starters, coordination type "1"

0.12	0.25	0.25	0.37	0.55	1	0.6 – 1	8 – 14
0.25	0.55	0.55	0.75	1.1	1.6	1 – 1.6	14 – 22
0.37	0.75	1.1	1.1	1.5	2.4	1.6 – 2.4	20 – 35
0.75	1.5	1.5	2.2	3	4	2.4 – 4	35 – 55
1.1	2.2	3	3	4	6	4 – 6	50 – 80
2.2	4	4	5.5	7.5	10	6 – 10	80 – 140
4	7.5	9	9	12.5	16	10 – 16	130 – 220
5.5	12.5	12.5	15	22	25	16 – 25	200 – 350
7.5	15	17.5	22	22	32	24 – 32	275 – 425
11	18.5	22	24	30	36	32 – 40	350 – 500

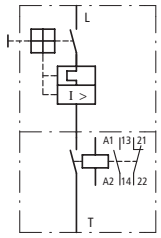
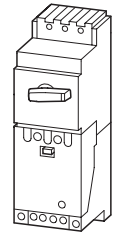

High-capacity compact starter, coordination type "2"

0.12	0.25	0.25	0.37	0.55	1	0.6 – 1	8 – 14
0.25	0.55	0.55	0.75	1.1	1.6	1 – 1.6	14 – 22
0.37	0.75	1.1	1.1	1.5	2.4	1.6 – 2.4	20 – 35
0.75	1.5	1.5	2.2	3	4	2.4 – 4	35 – 55
1.1	2.2	3	3	4	6	4 – 6	50 – 80
2.2	4	4	5.5	7.5	10	6 – 10	80 – 140
4	7.5	9	9	12.5	16	10 – 16	130 – 220
5.5	12.5	12.5	15	22	25	16 – 25	200 – 350
7.5	15	17.5	22	22	32	24 – 32	275 – 425
11	18.5	22	24	30	36	32 – 40	350 – 500

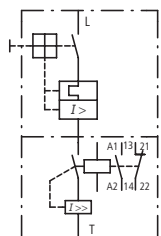
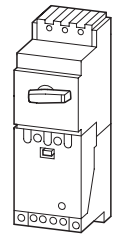

Moeller HPL0211-2004/2005

Type Article no.	Price See Price List	Std. pack	Notes
PKZ2/ZM-1/SE1A/11(230V50HZ) 063364		1 off	1 M/1 B auxiliary contact built into the contact module.
PKZ2/ZM-1,6/SE1A/11(230V50HZ) 063372			
PKZ2/ZM-2,4/SE1A/11(230V50HZ) 063382			
PKZ2/ZM-4/SE1A/11(230V50HZ) 063392			
PKZ2/ZM-6/SE1A/11(230V50HZ) 063402			
PKZ2/ZM-10/SE1A/11(230V50HZ) 063412			
PKZ2/ZM-16/SE1A/11(230V50HZ) 063422			
PKZ2/ZM-25/SE1A/11(230V50HZ) 063432			
PKZ2/ZM-32/SE1A/11(230V50HZ) 063442			
PKZ2/ZM-40/SE1A/11(230V50HZ) 063452			
PKZ2/ZM-1/S(230V50HZ) 063472		1 off	Rated short-circuit current $I_n = 100 \text{ kA}/400 \text{ V}$ High-capacity contact module has built-in auxiliary contacts: 1 M/1 B
PKZ2/ZM-1,6/S(230V50HZ) 063482			
PKZ2/ZM-2,4/S(230V50HZ) 063492			
PKZ2/ZM-4/S(230V50HZ) 063502			
PKZ2/ZM-6/S(230V50HZ) 063512			
PKZ2/ZM-10/S(230V50HZ) 063522			
PKZ2/ZM-16/S(230V50HZ) 063532			
PKZ2/ZM-25/S(230V50HZ) 063542			
PKZ2/ZM-32/S(230V50HZ) 063552			
PKZ2/ZM-40/S(230V50HZ) 063562			

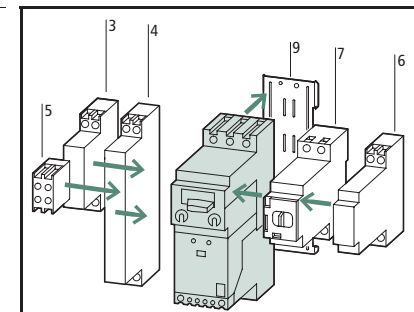





Accessories	Page
3 Standard auxiliary contact	a 8/45
4 Standard auxiliary contact	a 8/45
5 Trip-indicating auxiliary contact	a 8/45
6 Shunt release, undervoltage release	a 8/47
7 Remote operators	a 8/49
9 Clip plate	a 8/55
Other accessories	a 8/54
Further actuating voltages	a 8/61
Manual	a 8/55

Single-phasing sensitivity to IEC/EN 60947-4-1, VDE 0660 Part 102
Supplied fitted to C-PKZ2 clip plate, can be snap fitted to one or two IEC/EN 60715 top-hat rails, height 15 mm

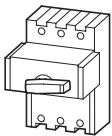
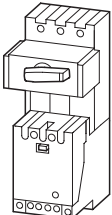
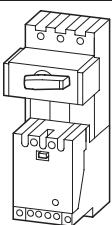
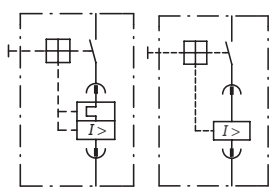
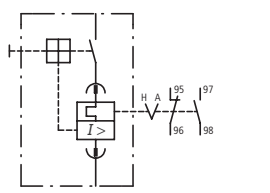
Adjustable overload release $I_r = 0.6 - 1.0 \times I_u$
Adjustable short-circuit release $I_{rm} = 8.5 - 14 \times I_u$
factory set to $12 \times I_u$

PTB 02 ATEX 3152
Observe manual.

	Rated uninter- rupted current I_u A	Type Article no.	Price See Price List	Std. pack
Basic unit, 3-pole				
	40	PKZ2 026606		1 off
 PKZ2 basic unit with S-PZK2 high-capacity contact module fitted (1 M, 1 BS). Supplied on C-PKZ2 clip plate. Cannot be combined with Z...-0,6-PKZ2	40	PKZ2/S(230V50HZ) 063572		
 PKZ2 basic unit with SE1A/11-PKZ2 contact module fitted (1 M, 1 BS). Supplied on C-PKZ2 clip plate. Cannot be combined with Z...-0,6-PKZ2	40	PKZ2/SE1A/11(230V50HZ) 082142		
<div style="display: flex; justify-content: space-between;"> <div style="width: 45%;">  <p>Circuit diagram M...PKZ2 for ZM...PKZ2</p> </div> <div style="width: 45%;">  <p>ZMR...PKZ2</p> </div> </div> <p>Adjustable: H Δ manual position or A Δ automatic position</p> <p>For EEx e applications the 95/96 break contact must always be used to de-energize the (high-capacity) contact module or contactor.</p> <p>Motor-protective trip blocks ZMR...-PKZ2 cannot be combined with U/A voltage releases and RE/RS remote operators.</p> <p>Further actuating voltages a 8/61 Manual a 8/55</p>				

	Max. motor rating					Rated uninter- rupted current I_u A	Setting range		Type Article no.	Price See Price List	Std. pack
	AC-3						Overload release	Short-circuit release			
	220 V	380 V	440 V	500 V	660 V	I_r A		I_{rm} A			
	230 V	400 V			690 V						
	240 V	415 V									
	P	P	P	P	P						
	kW	kW	kW	kW	kW						
Motor protective trip blocks, 3-pole											
With overload release											
	0.09	0.12	0.18	0.25	0.25	0.6	0.4 – 0.6	5 – 8	ZM-0,6-PKZ2 024232	1 off	
	0.12	0.25	0.25	0.37	0.55	1	0.6 – 1	8 – 14	ZM-1-PKZ2 028979		
	0.25	0.55	0.55	0.75	1.1	1.6	1 – 1.6	14 – 22	ZM-1,6-PKZ2 031352		
	0.37	0.75	1.1	1.1	1.5	2.4	1.6 – 2.4	20 – 35	ZM-2,4-PKZ2 033725		
	0.75	1.5	1.5	2.2	3	4	2.4 – 4	35 – 55	ZM-4-PKZ2 036098		
	1.1	2.2	3	3	4	6	4 – 6	50 – 80	ZM-6-PKZ2 038471		
	2.2	4	4	5.5	7.5	10	6 – 10	80 – 140	ZM-10-PKZ2 040844		
	4	7.5	9	9	12.5	16	10 – 16	130 – 220	ZM-16-PKZ2 043217		
	5.5	12.5	12.5	15	22	25	16 – 25	200 – 350	ZM-25-PKZ2 045590		
	7.5	15	17.5	22	22	32	24 – 32	275 – 425	ZM-32-PKZ2 047963		
	11	20	22	24	30	40	32 – 40	350 – 500	ZM-40-PKZ2 050336		
<p>Single-phasing sensitivity to IEC/EN 60947-4-1, VDE 0660 Part 102</p> <p>Overload releases, adjustable $I_r = 0.6 - 1.0 \times I_u$</p> <p>Adjustable short-circuit release $I_{rm} = 8.5 - 14 \times I_u$ Factory set to $12 \times I_u$</p> <p> PTB 02 ATEX 3152 Observe manual.</p>											

Moeller HPL0211-2004/2005

Max. motor rating AC-3					Rated uninter- rupted current	Setting range		Type Article no.	Price See Price List	Std. pack	
220 V	380 V	440 V	500 V	660 V		Overload release	Short-circuit release				
220 V	380 V	440 V	500 V	660 V	I_u A		I_r A				
230 V	400 V			690 V							
240 V	415 V										
P	P	P	P	P	I_u A		I_{rm} A				
kW	kW	kW	kW	kW							
Motor protective trip blocks, 3-pole											
With overload/relay function, with manual/automatic position											
	0.09	0.12	0.18	0.25	0.25	0.6	0.4 – 0.6	5 – 8	ZMR-0,6-PKZ2 033943	1 off	Single-phasing sensitiv- ity, adjustability and as with ZM blocks. When using motor protective trip blocks with overload relay function, an overload does not cause the motor-protective circuit- breaker to trip. The overload indication is produced by means of two auxiliary contacts.
	0.12	0.25	0.25	0.37	0.55	1	0.6 – 1	8 – 14	ZMR-1-PKZ2 033950		
	0.25	0.55	0.55	0.75	1.1	1.6	1 – 1.6	14 – 22	ZMR-1,6-PKZ2 033952		
	0.37	0.75	1.1	1.1	1.5	2.4	1.6 – 2.4	20 – 35	ZMR-2,4-PKZ2 033955		
	0.75	1.5	1.5	2.2	3	4	2.4 – 4	35 – 55	ZMR-4-PKZ2 033957		
	1.1	2.2	3	3	4	6	4 – 6	50 – 80	ZMR-6-PKZ2 033966		
	2.2	4	4	5.5	7.5	10	6 – 10	80 – 140	ZMR-10-PKZ2 033967		
	4	7.5	9	9	12.5	16	10 – 16	130 – 220	ZMR-16-PKZ2 033968		
	5.5	12.5	12.5	15	22	25	16 – 25	200 – 350	ZMR-25-PKZ2 033969		
	7.5	15	17.5	22	22	32	24 – 32	275 – 425	ZMR-32-PKZ2 033973		
	11	20	22	24	30	40	32 – 40	350 – 500	ZMR-40-PKZ2 033975		
Without overload release											
	–	–	–	–	–	0.6	–	5 – 8	M-0,6-PKZ2 004537	1 off	Adjustable short-circuit release $I_{rm} = 8.5 - 14 \times I_u$ Factory set to $12 \times I_u$
	–	–	–	–	–	1	–	8 – 14	M-1-PKZ2 004538		
	–	–	–	–	–	1.6	–	14 – 22	M-1,6-PKZ2 004539		
	–	–	–	–	–	2.4	–	20 – 35	M-2,4-PKZ2 004540		
	–	–	–	–	–	4	–	35 – 55	M-4-PKZ2 004541		
	–	–	–	–	–	6	–	50 – 80	M-6-PKZ2 004542		
	–	–	–	–	–	10	–	80 – 140	M-10-PKZ2 004543		
	–	–	–	–	–	16	–	130 – 220	M-16-PKZ2 004544		
	–	–	–	–	–	25	–	200 – 350	M-25-PKZ2 004545		
	–	–	–	–	–	32	–	275 – 425	M-32-PKZ2 004546		
	–	–	–	–	–	40	–	350 – 500	M-40-PKZ2 004547		

Notes

When using the M...-PKZ2 as short-circuit protection for motors with heavy starting duty, the rated operational current I_e must be over-dimensioned during engineering with the following factors:

CLASS	Factor
5	1.0
10	1.0
15	1.22
20	1.41
25	1.58
30	1.73
35	1.89
40	2.0



8/42 PKZ2 motor-protective circuit-breakers

Components for system protection



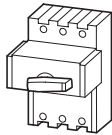
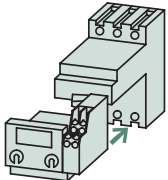
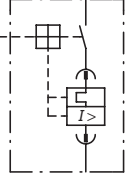
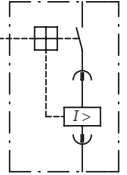
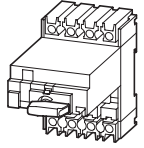

Moeller HPL0211-2004/2005

Motor-protective circuit-breakers

	Rated uninter- rupted current I_u A	Type Article no.	Price See Price List	Std. pack	
Basic unit, 3-pole 	40	PKZ2 026606		1 off	 Contact sequence for ZM... -PKZ2(4) M... -PKZ2(4)  
Basic unit, 4-pole 	40	PKZ24 004521		1 off	





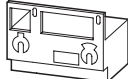
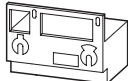





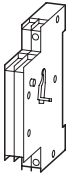

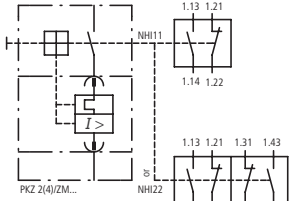
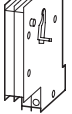
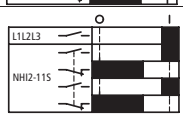
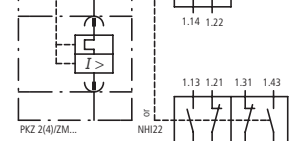
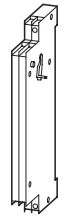
Moeller HPL0211-2004/2005

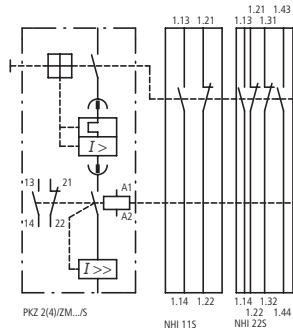
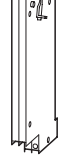
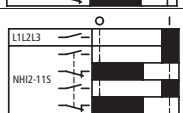
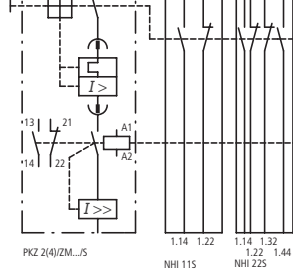
	Rated uninterrupted current I_u A	Setting range		Type Article no.	Price See Price List	Std. pack	
		Overload release I_r A	Short-circuit release I_{rm} A				
							
Trip block for distribution circuit protection							
3-pole							
With overload release							
	10	6 – 10	50 – 80	ZM-10-8-PKZ2 062201		1 off	Overload releases, adjustable $I_r = 0.6 - 1.0 \times I_u$ Adjustable short-circuit release $I_{rm} = 5 - 8.5 \times I_u$ factory set to $5 \times I_u$
	16	10 – 16	80 – 140	ZM-16-8-PKZ2 059828			
	25	16 – 25	130 – 210	ZM-25-8-PKZ2 057455			
	32	24 – 32	160 – 280	ZM-32-8-PKZ2 055082			
	40	32 – 40	200 – 350	ZM-40-8-PKZ2 052709			
Without overload release							
	10	–	50 – 80	M-10-8-PKZ2 004532		1 off	Adjustable short-circuit release $I_{rm} = 5 - 8.5 \times I_u$ factory set to $5 \times I_u$
	16	–	80 – 140	M-16-8-PKZ2 004533			
	25	–	130 – 210	M-25-8-PKZ2 004534			
	32	–	160 – 280	M-32-8-PKZ2 004535			
	40	–	200 – 350	M-40-8-PKZ2 004536			
4-pole							
With overload releases in all four poles							
	10	6 – 10	50 – 80	ZM-10-8-PKZ24 004526		1 off	Overload releases, adjustable $I_r = 0.6 - 1.0 \times I_u$ Adjustable short-circuit release $I_{rm} = 5 - 8.5 \times I_u$ factory set to $5 \times I_u$ PKZ24/ZM-...-8 circuit-breakers protect in all 4-poles
	16	10 – 16	80 – 140	ZM-16-8-PKZ24 004525			
	25	16 – 25	130 – 210	ZM-25-8-PKZ24 004524			
	32	24 – 32	160 – 280	ZM-32-8-PKZ24 004523			
	40	32 – 40	200 – 350	ZM-40-8-PKZ24 004522			
Without overload release							
	10	–	50 – 80	M-10-8-PKZ24 004527		1 off	Adjustable short-circuit release $I_{rm} = 5 - 8.5 \times I_u$ factory set to $5 \times I_u$ PKZ24/ZM-...-8 circuit-breakers protect in all 4-poles
	16	–	80 – 140	M-16-8-PKZ24 004528			
	25	–	130 – 210	M-25-8-PKZ24 004529			
	32	–	160 – 280	M-32-8-PKZ24 004530			
	40	–	200 – 350	M-40-8-PKZ24 004531			

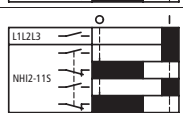
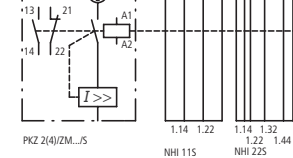
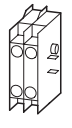

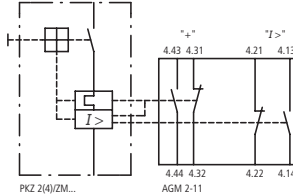
Moeller HPL0211-2004/2005

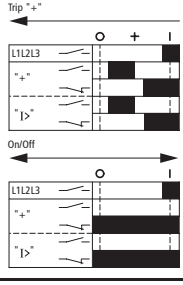
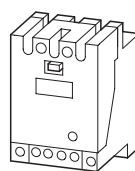
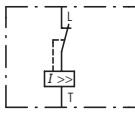
Contacts	Contact sequence	Contact sequence	Type suffix	Price	Std. pack
M = Make B = Break			Article no. for ordering with basic unit	See Price List	
Standard auxiliary contact					
For motor-protective circuit-breakers, circuit-breakers and (high-capacity) compact starters					
 1 M	 1 B		+NHI11-PKZ2 093050		1 off
 2 M	 2 B		+NHI22-PKZ2 095423		1 off
For (high-capacity) compact starters					
 1 M	 1 B		+NHI11S-PKZ2 005250		1 off
 2 M	 2 B		+NHI22S-PKZ2 002877		
 2 x 1 M	 2 x 1 B		+NHI2-115-PKZ2 012369		
Trip-indicating auxiliary contact with short-circuit indicator					
For motor-protective circuit-breakers, circuit-breakers and (high-capacity) compact starters					
 2 x 1 M	 2 x 1 B		+AGM2-11-PKZ2 019488		1 off
Short-circuit indicators					
For motor-protective circuit-breakers, circuit-breakers and (high-capacity) compact starters					
			+K-AGM-PKZ2 024234		1 off
Current limiter					
To increase the switching capacity of non-inherently short-circuit proof motor-protective circuit-breakers to 100 kA/500 V					
			+CL-PKZ2 078812		1 off

Moeller HPL0211-2004/2005

Type	Price	Std. pack	Notes
Article no. When ordered separately	See Price List		
NHI11-PKZ2 090677		1 off	Can be fitted to the circuit-breakers and (high-capacity) compact starters.
NHI22-PKZ2 097796		1 off	Can be combined with AGM trip-indicating auxiliary contacts
NHI11S-PKZ2 007623		1 off	Can be fitted to the starter combination
NHI22S-PKZ2 000504			Can be combined with AGM trip-indicating auxiliary contacts,
NHI2-115-PKZ2 009996			
AGM2-11-PKZ2 017115		1 off	Differential remote indication: a) General trip indication "+", overload, b) Short-circuit trip Can be fitted to the circuit-breakers and (high-capacity) compact starters, Can be combined with NHI... or NHI...S standard auxiliary contacts
K-AGM-PKZ2 021861		1 off	Local short-circuit indication by indicator, can be reset. Can be used in circuit-breakers and (high-capacity) compact starters.
CL-PKZ2 076439		1 off	Max. rated operational voltage $U_e = 690$ V Rated uninterrupted current $I_u = 40$ A Can be fitted to circuit-breaker or mounted separately on EZ base C-PKZ2 clip plate required as standard

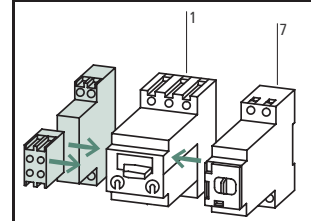

Accessories	Page
1 Motor-protective circuit-breaker, circuit-breakers	a 8/37
7 Remote operators	a 8/49
Additional accessories	a 8/54

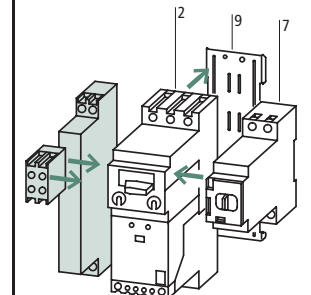

Accessories	Page
2 (High-capacity) compact starter	a 8/39
7 Remote operators	a 8/49
9 Clip plate	a 8/55
Additional accessories	a 8/54

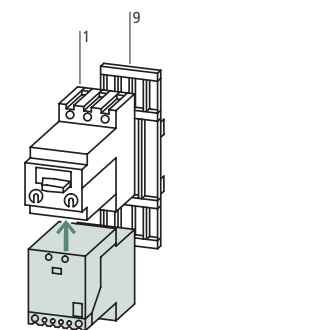

Accessories	Page
1 Motor-protective circuit-breaker, circuit-breakers	a 8/37
9 Clip plate	a 8/55
Additional accessories	a 8/54

Moeller HPL0211-2004/2005

Circuit diagram	Contact sequence	Actuating voltage Voltage and frequency combination with one coil in the voltage release	Type suffix Article no. for ordering with basic unit	Price See Price List	Std. pack
Shunt release					
For AC and DC voltage					
		24 V DC 48 V DC 60V DC	+A-PKZ2-A 063966		1 off
		24 V 50 Hz 48 V 50 Hz			
		24 V 60 Hz 48 V 60 Hz			
		110V DC 125V DC 250V DC	+A-PKZ2-B 063965		
		110 V 50 Hz 127 V 50 Hz 220 V 50 Hz			
		230 V 50Hz 240V 50Hz			
		110 V 60 Hz 120 V 60 Hz 208 V 60 Hz	+A-PKZ2-C 063962		
		220 V 60 Hz 240 V 60 Hz			
		380 V 50 Hz 400 V 50 Hz 415 V 50 Hz			
		440 V 50 Hz 500 V 50 Hz			
		480 V 60 Hz 600 V 60 Hz			
Undervoltage release, non-delayed					
Without auxiliary contact					
	For AC	—	+U-PKZ2(230V50HZ) 065760		1 off
	For DC	—	+U-PKZ2(24VDC) 002558		1 off
With auxiliary contact For AC					
	On		+U-HI20-PKZ2(230V50HZ) 065762		1 off
	Off/Trip				
Undervoltage release off-delayed, delay time 200 ms					
With auxiliary contact For AC					
	On		+UVHI-PKZ2(230V50HZ) 065764		1 off
	Off/Trip				

Moeller HPL0211-2004/2005

Type Article no. when ordered sep- arately	Price See Price List	Notes
A-PKZ2-A 063967		Can be fitted to motor-protective circuit-breaker, circuit-breaker, (high-capacity) compact starter Can be combined with remote operator.
A-PKZ2-B 063964		
A-PKZ2-C 063930		
U-PKZ2(230V50HZ) 065766		Can be fitted to motor-protective circuit-breaker, circuit-breaker, (high-capacity) compact starter Can be combined with remote operator. When combined with circuit-breaker, can be used as Emergency-Stop device to IEC/EN 60204.
U-PKZ2(24VDC) 014463		
U-HI20-PKZ2(230V50HZ) 065768		Can be fitted to motor-protective circuit-breaker, circuit-breaker, (high-capacity) compact starter Can be combined with remote operator. 2 integral early-make contacts. When combined with circuit-breaker, can be used as Emergency-Stop device to IEC/EN 60204. When the circuit-breaker is in the tripped position "+", the auxiliary contacts are closed. The undervoltage release can be energized early by means of an additional link (see circuit diagram). This function cannot be used in combination with RE/RS-PKZ2 (remote operator).
UVHI-PKZ2(230V50HZ) 065770		Can be fitted to motor-protective circuit-breaker, circuit-breaker, (high-capacity) compact starter Can be combined with remote operator. 2 integral early-make contacts. Voltage dips ≅ 200 ms do not result in disconnection, Contact time on energization 200 ms. When the circuit-breaker is in the tripped position "+", the auxiliary contacts are closed.

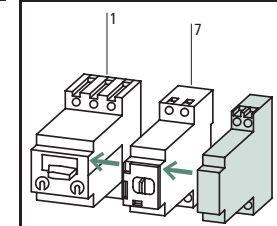

Accessories	Page
1 Motor-protective circuit-breaker, circuit-breakers	a 8/37
7 Remote operators	a 8/49
Additional accessories	a 8/54

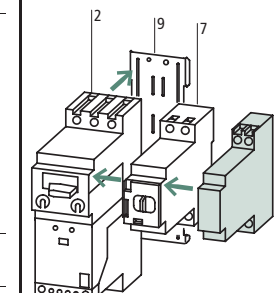

Accessories	Page
2 (High-capacity) compact starter	a 8/39
7 Remote operators	a 8/49
9 Clip plate	a 8/55
Additional accessories	a 8/54

Motor-protective circuit-breakers



Contact sequence

Circuit diagram for pulsed operation
OFF and RESET separate OFF equals RESET

RE-PKZ2 remote operator

Actuation via auxiliary contact

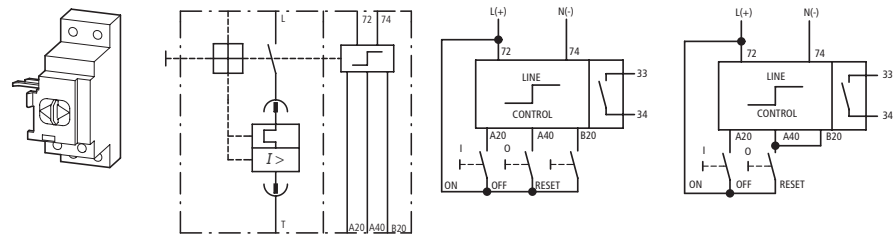

Power and control sections have the same potential. Can be actuated by a single pulse ($\geq 2 \text{ VA/W}$, 15 ms) or by maintained contact. When activated, the power section is energized directly from the mains supply (700 VA/W, 30 ms). Control section can be activated by: NHI, AGM, ETS4-VS3, EK..., PLC with isolated contacts without RC suppressor.

RS-PKZ2 remote operator

Actuation from PLC semiconductor outputs

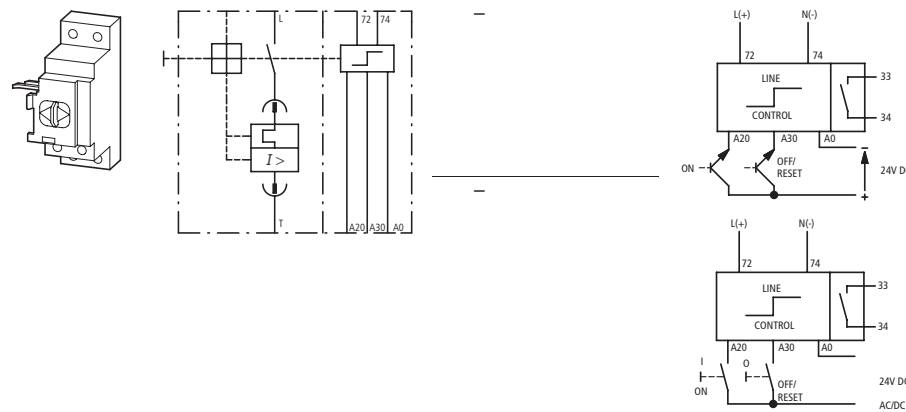

Power and control sections electrically isolated from one another. Control section always 24 V. Safe isolation between power and control section is assured. Can be actuated by a single pulse ($\geq 2 \text{ VA/W}$, 15 ms) or by maintained contact. The control section can be activated directly from the PLC electronic outputs (24 V DC). When activated, the power section is energized directly from the mains supply (700 VA/W, 30 ms).

Type Article no.	Price See Price List	Std. pack	Notes
RE-PKZ2(220-240V50/60HZ,DC) 063676		1 off	Can be fitted to the circuit-breakers and (high-capacity) compact starters. Remote On/Off switching of circuit-breaker and trip reset to OFF. Remote operator can be switched off locally and the thumb-grip locked with a 6 mm pad-lock. Suitable for AC or DC voltage. Can be combined with U, U-HI20, UVHI-PKZ2 or A-PKZ2 voltage release. NHI standard auxiliary contact is always required for the combination of circuit-breaker and RE/RS-PKZ2 remote operator. Cannot be combined in conjunction with (R)H-PKZ2 door coupling handle. Mounting in "I" and "O" possible. Internal electronic interlocking always assigns top priority to "OFF". Green slide background indicates Δ "manual" position contacts (33/34) open. Red slide background indicates Δ "auto" position contacts (33/34) closed. In "manual" position remote switching is not possible.
RE-PKZ2(24V50/60HZ,DC) 063670		1 off	
RS-PKZ2(220-240V50/60HZ,DC) 063688		1 off	
RS-PKZ2(24V50/60HZ,DC) 063682		1 off	

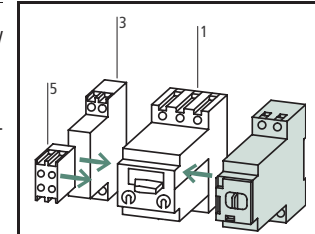

Accessories	Page
1 Motor-protective circuit-breaker, circuit-breakers	a 8/37
3 Standard auxiliary contact	a 8/45
5 Trip-indicating auxiliary contact	a 8/45
Additional accessories	a 8/54

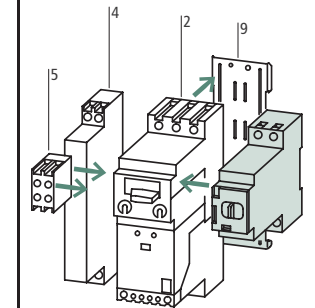

Accessories	Page
2 (High-capacity) compact starter	a 8/39
4 Standard auxiliary contact	a 8/45
5 Trip-indicating auxiliary contact	a 8/45
9 Clip plate	a 8/55
Other actuating voltages and supply voltages	a 8/49

Minimum command time:

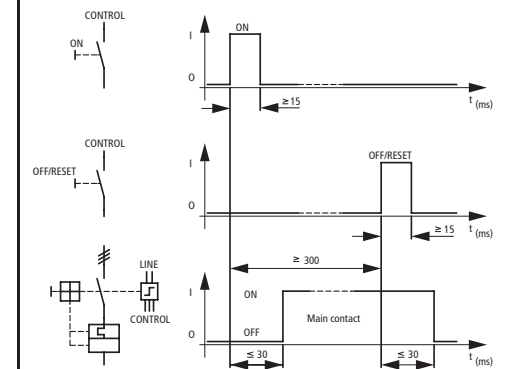

Moeller HPL0211-2004/2005

Contact sequence	Max. motor rating AC-3					Auxiliary contacts M = Make B = Break		For use with
	220 V	380 V	440 V	500 V	660 V			
	230 V	400 V			690 V			
	240 V	415 V						
	P	P	P	P	P			
	kW	kW	kW	kW	kW			

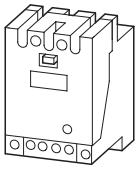
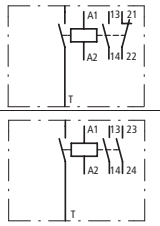
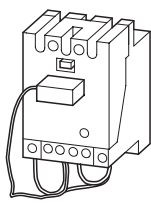
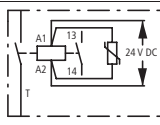
Contact module		11	20	22	24	30	1 M	1 B	PKZ2(4)
									
									

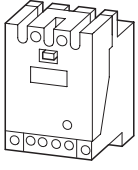
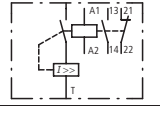
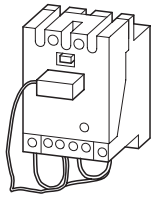
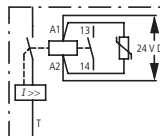
High-capacity contact module with current limiting contacts		11	20	22	24	30	1 M	1 B	PKZ2(4)
									
									

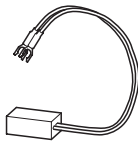
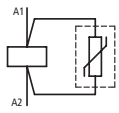
Suppressor, Varistor suppressor		24 – 48 V AC	110 – 250 V AC	380 – 415 V AC						S(E1A)-...-PKZ2
										

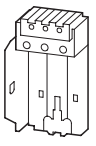
Base for separate mounting										S(E1A)-...-PKZ2 CL-PKZ2
										

Moeller HPL0211-2004/2005

Type Article no.	Price See Price List	Std. pack	Notes
SE1A/11-PKZ2(230V50HZ) 063711		1 off	<p>Clip plate for snap fitting the combination to be ordered separately. Can be fitted to 3 or 4-pole circuit-breaker. When combined with a clip plate can be snap fitted to one IEC/EN 60715 top-hat rail with 15 mm height or two with 15 mm height.</p> <p>Can be mounted separately using base (see below), RC suppressor on request.</p> <p>DC version: The coil cannot be changed. The HI10-S-PKZ2 integral auxiliary contact is freely configurable. The auxiliary contact cannot be changed.</p> <p>DC version with varistor suppressor present. High-capacity contact module with serial no. 01 suitable for mounting with MV-PKZ2.</p>
SE1A/20-PKZ2(230V50HZ) 063718			
SE1A-G-10-PKZ2(24VDC) 058856			
S-PKZ2(230V50HZ) 063696		1 off	
S/HI20-S-PKZ2(230V50HZ) 063703			
S-G-PKZ2(24VDC) 070921			
VGSPKZ48 063974		10 off	For (high-capacity) contact modules with 50/60 Hz AC operation
VGSPKZ250 063973			
VGSPKZ415 063972			
EZ-PKZ2 028596		1 off	<p>For retrofitting of (high-capacity) contact module or current limiter, separate mounting</p> <p>With separate contacts also provides fixing base for HI11-S/EZ-PKZ2 auxiliary contacts.</p> <p>Can be snap fitted on IEC/EN 60715 top-hat rail, or optional M4 screw fixing</p>

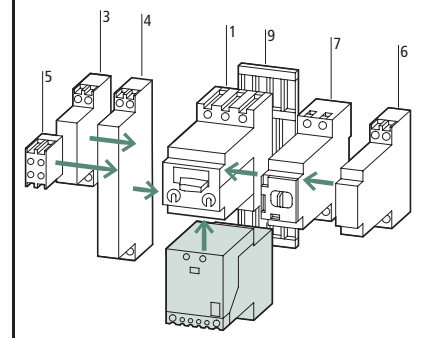

Accessories	Page
1 Motor-protective circuit-breaker, circuit-breakers	a 8/37
3 Standard auxiliary contact	a 8/45
4 Standard auxiliary contact	a 8/45
5 Trip-indicating auxiliary contact	a 8/45
6 Shunt release, undervoltage release	a 8/47
7 Remote operators	a 8/49
9 Clip plate	a 8/55
Further actuating voltages	a 8/67
Additional accessories	a 8/54

Motor-protective circuit-breakers

Motor-protective circuit-breakers



Contacts
M = Make
B = Break

Contact sequence

Contact sequence

Control circuit terminal



Auxiliary contact for (high-capacity) contact module, separate mounting

Can be fitted on side of base for separate mounting

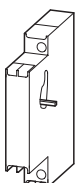

1 M

1 B

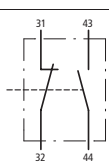
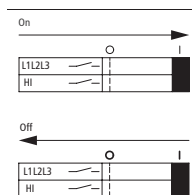

Auxiliary contacts for (high-capacity) contact module

Auxiliary contact for exchange of integrated auxiliary contact in (high-capacity) contact module
Exchange not possible with SE1A-G-10-PKZ2 contact module or S-G-PKZ2 high-capacity contact module



1 M

1 B

2 M

Single coil for (high-capacity) contact module

RC suppressor on request



Mechanical interlock

For mechanically interlocking two separately mounted (high-capacity) contact modules or two (high-capacity) compact starters.
4 end brackets are included
Can be combined with S-PKZ2 high-capacity contact module serial no. 01



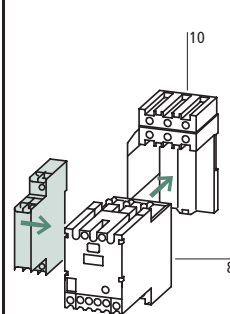

Type Article no.	Price See Price List	Std. pack	Notes								
ST-PKZ2 010998		3 off	1 set = 2 off VDE/IEC and UL/CSA compliant Fast-on connectors can be fitted (insulated/non-insulated) 2.8 mm Max. cross-section 0.5 – 1 mm ² , 20 – 16 AWG Max. current tapped-off 1 A or 15 % of the set value Increase setting of thermal release accordingly. Enables control circuit supply to be tapped off between motor-protective circuit-breaker or circuit-breaker and (high-capacity) contact module.								
HI11-S/EZ-PKZ2 090305		1 off	 <table border="1"> <thead> <tr> <th>Accessories</th> <th>Page</th> </tr> </thead> <tbody> <tr> <td>8 High-capacity contact module</td> <td>a 8/51</td> </tr> <tr> <td>10 Base for separate mounting</td> <td>a 8/51</td> </tr> <tr> <td>Further actuating voltages</td> <td>a 8/67</td> </tr> </tbody> </table>	Accessories	Page	8 High-capacity contact module	a 8/51	10 Base for separate mounting	a 8/51	Further actuating voltages	a 8/67
Accessories	Page										
8 High-capacity contact module	a 8/51										
10 Base for separate mounting	a 8/51										
Further actuating voltages	a 8/67										
HI11-S-PKZ2 033936		1 off									
HI20-S-PKZ2 033935		1 off									
J-S-PKZ2(230V50HZ) 063725		1 off	-								
MV-PKZ2 033938		1 off	-								



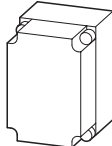
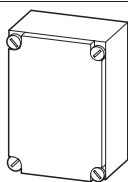
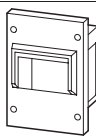
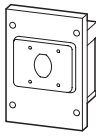

Motor-protective circuit-breakers

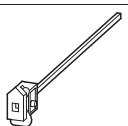
Motor-protective circuit-breakers



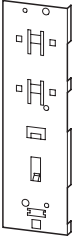
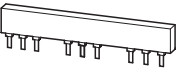
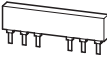

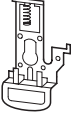

	For use with	Colour	Type Article no.	Price See Price List	Std. pack		
Insulated enclosures for surface mounting							
For motor-protective circuit-breaker, 3 or 4-pole circuit-breaker							
	IP40 degree of protection, cover with cut-out in standard front dimension incl. blanking strip	PKZ2/ZM-... +NHI + AGM + U or A or RE or RS PKZ24/ZM-... + NHI + AGM + U or A	–	C119EA-PKZ2 026234		1 off	Integrated IEC/EN 60715 top-hat rail, separate terminal for PE(N) and N connection
	IP54 degree of protection prepared for mounting of a (R)H-PKZ2 door coupling handle	PKZ2/ZM-... + NHI + AGM + U or A + (R)H	–	C119EB-PKZ2 028607			Incl. cable entries 2 × PG 16/21/29
			–	C119ED-PKZ24 005145			L-PKZ0 indicator light can be fitted
For 3-pole compact starter, high-capacity compact starter, combination circuit-breakers (Kombi)							
	IP40 degree of protection, cover with cut-out in standard front dimension incl. blanking strip	PKZ2/ZM-.../S(E1A) + NHI + AGM + RE or RS or U or A	–	C123EA-PKZ2 087936		1 off	Integrated L3/5-CI23 mounting plate
	IP54 degree of protection prepared for mounting of a (R)H-PKZ2 door coupling handle	PKZ2/ZM-.../S + NHI + AGM + U or A + (R)H	–	C123EB-PKZ2 090309		1 off	Prepared for a compact starter or a PKZ2/ZM-.../S high-capacity compact starter without fitted clip plate
Insulated enclosures for flush mounting							
For motor-protective circuit-breaker, 3 or 4-pole circuit-breaker							
	IP41 degree of protection, grey front plate with retaining frame, integral PE(N) terminal	PKZ2/ZM-... + NHI + AGM PKZ2/ZM-... +U or A (undervoltage or shunt release) PKZ24/ZM-...	–	E-PKZ2 003218		1 off	For mounting in side panel or door Vertical mounting position L-PKZ0 indicator light can be fitted
	IP54 degree of protection (R)H-PKZ2 door coupling handle additionally required	PKZ2/ZM-... + NHI + AGM PKZ2/ZM-... +U or A (undervoltage or shunt release) PKZ24/ZM-...	–	E54-PKZ2 033939		1 off	
Neutral terminal							
For connection of a 5th conductor							
		E-PKZ2E54-PKZ2	–	N-PKZ2 003219		1 off	–
Door coupling handle							
Degree of protection IP65							
	For use on main switches to IEC/EN 60204	–	Black	H-PKZ2 043218		1 off	Lockable in 0 or I position Suitable for 3 padlocks with 4 – 8 mm hasp thickness Additional front labels: ZFS...-T0 or ZFS...-P3 17 × 48 mm or 27 × 88 mm and ZFS60-NZM7 17 × 64 mm can be used
	For use in MCC distribution boards with PKZ2 turned through 90°. For use as main switch to IEC/EN 60204	–	Black	H-PKZ2-MCC 201427			
	For use as a main switch with Emergency-Stop function, to EN 60204	–	Red-yellow	RH-PKZ2 045591			
	For use in MCC distribution boards with PKZ2 turned through 90°. For use as a main switch with Emergency-Stop function, to EN 60204	–	Red-yellow	RH-PKZ2-MCC 201428			
Plug-fit extension shaft for door coupling handle							
Can be extended as required for mounting depths from 171 – 300 mm							
	–	–	–	A-H-PKZ2 047964		5 off	–

Moeller HPL0211-2004/2005

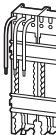
For use with	Type Article no.	Price See Price List	Std. pack
Clip plates			
For optional snap-fitting and M4 screw fixing of circuit-breaker with (high-capacity) contact module or current limiter.			
	Can be used with AD busbar adapter	C-PKZ2 052710	2 off Can be snap fitted to IEC/EN 60715 top-hat rails, with 15 mm height or two top-hat rails exceeding 10 mm height
Three-phase commoning link			
	For wiring 3 PKZ2s, space is provided for either 2 auxiliary contacts or 2 voltage releases	B3.1/3-PKZ2 033940	5 off
	For wiring of 2 PKZ2s, space is provided for either 1 auxiliary contact or 1 voltage release	B3.1/2-PKZ2 063969	5 off
Incoming terminal			
For three-phase commoning link, protected against accidental contact $U_e = 690 \text{ V}$, $I_u = 120 \text{ A}$			
	–	BK50/3-PKZ2 033941	2 off For connection of: For max. $1 \times 50 \text{ mm}^2$ or $2 \times 35 \text{ mm}^2$ one above the other; min. $1 \times 1 \text{ mm}^2$ or $2 \times 1 \text{ mm}^2$
Shroud for unused terminals			
Protection against direct contact. To cover unused terminals on three-phase commoning link			
	–	H-B3-PKZ2 063968	10 off Latching feature must be provided on three-phase commoning link
Padlocking feature			
For locking of the circuit-breaker in 0-position with open control panel door (intermediate fitting),			
	–	SVB-PKZ2 050337	5 off Suitable for 3 padlocks with 5 – 8 mm hasp thickness
Coding pins			
For coding (in dual coding system) the devices assigned from trip block to PKZ2(4) basic unit			
	–	CS-PKZ2 055083	1 off
Documentation			
PKZ2 motor-protective circuit-breaker, over-load monitoring of EEx e motors	German/English	AWB1210-1485D/GB 266166	1 off

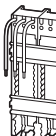

	Rated operational voltage U_e V	Rated operational current I_e A	Adapter width mm	Type Article no.	Price See Price List	Std. pack	
Component adapter, 3-pole							
For mounting on flat copper busbars 20×5 and Cu profiled busbars 800 A with 60 mm interval between busbar centres							
	690	40	72	AD40/5-1 025401		1 off	Mounted by latching onto de-energized busbar PKZ2/ZM-... circuit-breaker or PKZ2/ZM-.../S(E1A) (high-capacity) compact starter as a direct-on-line starter up to 18.5 kW/400 V
	690	40	144	AD40/5-2 025403		1 off	
For mounting on flat copper busbars 30×10 and 20×10 mm and Cu profiled busbars 1600 A with 60 mm interval between busbar centres							
	690	40	72	AD40/10-1 025402		1 off	Mounted by latching onto de-energized busbar PKZ2/ZM-... circuit-breaker or PKZ2/ZM-.../S(E1A) (high-capacity) compact starter as a direct-on-line starter up to 18.5 kW/400 V
	690	40	144	AD40/10-2 025404		1 off	
Adapter extension							
Can be fitted onto AD... to extend mounting width Only for component adapter for motor-protective circuit-breaker							
	-	-	9	AD-E 060511		1 off	Can be fitted onto AD... to extend mounting width



Moeller HPL0211-2004/2005

Compact starter PKZM0 and contact modules with 1 make/1 break auxiliary contact										
AC	PKZM0 -0,16/ SE00- 11(...)	PKZM0 -0,25/ SE00- 11(...)	PKZM0 -0,4/ SE00- 11(...)	PKZM0 -0,63/ SE00- 11(...)	PKZM0 -1/ SE00- 11(...)	PKZM0 -1,6/ SE00- 11(...)	PKZM0 -2,5/ SE00- 11(...)	PKZM0 -4/ SE00- 11(...)	PKZM0 -6,3/ SE00- 11(...)	PKZM0 -10/ SE00- 11(...)
	Article no. ¹⁾	Article no. ¹⁾	Article no. ¹⁾	Article no. ¹⁾	Article no. ¹⁾	Article no. ¹⁾	Article no. ¹⁾	Article no. ¹⁾	Article no. ¹⁾	Article no. ¹⁾
Standard voltage	See price list	See price list	See price list	See price list	See price list	See price list	See price list	See price list	See price list	See price list
24 V 50 Hz	072919	072920	072921	072922	072923	072924	072925	072926	072927	072928
48 V 50 Hz	073318	073345	073372	073399	073426	073453	073480	073507	073534	074322
240V 50Hz	073320	073347	073374	073401	073428	073455	073482	073509	073536	053174
24 V 60 Hz	073326	073353	073380	073407	073434	073461	073488	073515	073542	055173
110 V 60 Hz	073329	073356	073383	073410	073437	073464	073491	073518	073545	055496
115 V 60 Hz	073330	073357	073384	073411	073438	073465	073492	073519	073546	055943
42V 50Hz, 48 V 60 Hz	050282	050424	052234	053006	053161	053435	053444	053453	053462	058775
110V 50Hz, 120 V 60 Hz	050283	050651	052338	053007	053346	053436	053445	053454	053463	058790
190V 50Hz, 220 V 60 Hz	050284	050788	052339	053008	053428	053437	053446	053455	053464	058805
220V 50Hz, 240 V 60 Hz	050285	050844	052703	053009	053429	053438	053447	053456	053465	058820
230V 50Hz, 240 V 60 Hz	050286	051145	052704	053010	053430	053439	053448	053457	053466	058835
380V 50Hz, 440 V 60 Hz	050287	051146	052765	053011	053431	053440	053449	053458	055100	058850
400V 50Hz, 440 V 60 Hz	050288	051147	052872	053158	053432	053441	053450	053459	055706	059292
415V 50Hz, 480 V 60 Hz	050256	051148	053004	053159	053433	053442	053451	053460	044514	059293
24 V 50/60 Hz	073337	073364	073391	073418	073445	073472	073499	073526	073553	057309
42 V 50/60 Hz	073338	073365	073392	073419	073446	073473	073500	073527	073554	057310
110 V 50/60 Hz	073340	073367	073394	073421	073448	073475	073502	073529	073556	057312
230 V 50/60 Hz	050281	050423	052233	053005	053160	053434	053443	053452	053461	057891
DC										
Standard voltage	See price list	See price list	See price list	See price list	See price list	See price list	See price list	See price list	See price list	See price list
12 V DC	058163	058168	058173	058178	058183	058188	058193	058198	058203	058208
24 V DC	072909	072910	072911	072912	072913	072914	072915	072916	072917	072918
48 V DC	058164	058169	058174	058179	058184	058189	058194	058199	058204	058209
60V DC	058165	058170	058175	058180	058185	058190	058195	058200	058205	058210
110V DC	058166	058171	058176	058181	058186	058191	058196	058201	058206	058211
220V DC	058167	058172	058177	058182	058187	058192	058197	058202	058207	058212

Notes

¹⁾ The article no. is formed from the combination of type and actuating voltage.
Devices with **dual-voltage coils** must be ordered using **one** order number.



High-capacity compact starters

PKZM0 and high-capacity contact module with 1 make/1 break auxiliary contact

AC	PKZM0 -0,16/ S00-11(...)	PKZM0 -0,25/ S00-11(...)	PKZM0 -0,4/ S00-11(...)	PKZM0 -0,63/ S00-11(...)	PKZM0 -1/ S00-11(...)	PKZM0 -1,6/ S00-11(...)	PKZM0 -2,5/ S00-11(...)	PKZM0 -4/ S00-11(...)	PKZM0 -6,3/ S00-11(...)	PKZM0 -10/ S00-11(...)
	Article no. ¹⁾	Article no. ¹⁾	Article no. ¹⁾	Article no. ¹⁾	Article no. ¹⁾	Article no. ¹⁾	Article no. ¹⁾	Article no. ¹⁾	Article no. ¹⁾	Article no. ¹⁾
Standard voltage	See price list	See price list	See price list	See price list	See price list	See price list	See price list	See price list	See price list	See price list
24 V 50 Hz	073029	073030	073031	073032	073033	073034	073035	073036	073037	073038
48 V 50 Hz	060820	060848	060875	060902	060929	060956	060983	061010	061037	062215
240V 50Hz	060822	060850	060877	060904	060931	060958	060985	061012	061039	062253
24 V 60 Hz	060828	060856	060883	060910	060937	060964	060991	061018	061045	064166
110 V 60 Hz	060831	060859	060886	060913	060940	060967	060994	061021	061048	064604
115 V 60 Hz	060832	060860	060887	060914	060941	060968	060995	061022	061049	064675
42V 50Hz, 48 V 60 Hz	044516	044525	044534	044543	044552	044561	044570	044579	044588	044597
110V 50Hz, 120 V 60 Hz	044517	044526	044535	044544	044553	044562	044571	044580	044589	044598
190V 50Hz, 220 V 60 Hz	044518	044527	044536	044545	044554	044563	044572	044581	044590	044599
220V 50Hz, 240 V 60 Hz	044519	044528	044537	044546	044555	044564	044573	044582	044591	044600
230V 50Hz, 240 V 60 Hz	044520	044529	044538	044547	044556	044565	044574	044583	044592	044601
380V 50Hz, 440 V 60 Hz	044521	044530	044539	044548	044557	044566	044575	044584	044593	044602
400V 50Hz, 440 V 60 Hz	044522	044531	044540	044549	044558	044567	044576	044585	044594	044603
415V 50Hz, 480 V 60 Hz	044523	044532	044541	044550	044559	044568	044577	044586	044595	044604
24 V 50/60 Hz	060839	060867	060894	060921	060948	060975	061002	061029	061056	066982
42 V 50/60 Hz	060840	060868	060895	060922	060949	060976	061003	061030	061057	067043
110 V 50/60 Hz	060842	060870	060897	060924	060951	060978	061005	061032	061059	067245
230 V 50/60 Hz	044515	044524	044533	044542	044551	044560	044569	044578	044587	044596
DC										
Standard voltage	See price list	See price list	See price list	See price list	See price list	See price list	See price list	See price list	See price list	See price list
12 V DC	056258	056264	056270	056276	056282	056288	056294	056300	056306	056312
24 V DC	056257	056263	056269	056275	056281	056287	056293	056299	056305	056311
48 V DC	056259	056265	056271	056277	056283	056289	056295	056301	056307	056313
60V DC	056260	056266	056272	056278	056284	056290	056296	056302	056308	056314
110V DC	056261	056267	056273	056279	056285	056291	056297	056303	056309	056315
220V DC	056262	056268	056274	056280	056286	056292	056298	056304	056310	056316

Notes

¹⁾ The article no. is formed from the combination of type and actuating voltage.
Devices with **dual-voltage coils** must be ordered using **one** order number.



Moeller HPL0211-2004/2005

Shunt releases, undervoltage releases

	When ordered with basic unit		When ordered separately	
	+A-PKZ0(...)	+U-PKZ0(...)	A-PKZ0(...)	U-PKZ0(...)
AC	Article no. ¹⁾	Article no. ¹⁾	Article no. ¹⁾	Article no. ¹⁾
Standard voltage	See price list	See price list	See price list	See price list
24 V 50 Hz	073305	073253	073181	073129
48 V 50 Hz	073313	073262	073183	073131
110 V 50 Hz	073292	073240	073184	073132
220 V 50 Hz	073300	073248	073186	073134
230 V 50Hz	073302	073250	073187	073135
240V 50Hz	073303	073251	073188	073136
380 V 50 Hz	073308	073256	073189	073137
400 V 50 Hz	073309	073257	073190	073138
415 V 50 Hz	073310	073258	073191	073139
120 V 60 Hz	073295	073243	073195	073143
240 V 60 Hz	073304	073252	073198	073146
440 V 60 Hz	082192	082193	082164	082161
480 V 60 Hz	051492	073261	073199	073147
Non-standard voltages with the exception of the given standard voltages ²⁾ .	See price list	See price list	See price list	See price list
...V 50Hz (24 – 500V)	914740	914742	982165	982162
...V 60Hz (24 – 600V)	914739	914741	982166	982163
DC				
Standard voltage	See price list	See price list	See price list	See price list
24 V DC	073306	–	073200	–
48 V DC	073314	–	073201	–
60V DC	073315	–	073202	–
110V DC	073294	–	073203	–
125V DC	073296	–	073204	–
220V DC	073301	–	073205	–
250V DC	073307	–	073206	–

Notes

¹⁾ The article no. is formed from the combination of type and actuating voltage.

²⁾ With non-standard voltages the required actuating voltage from the defined range (...-...V) must be stated.



8/60 PKZM0 motor-protective circuit-breakers

Actuating voltages

Moeller HPL0211-2004/2005

Contact module, high-capacity contact module
with 1 make/1 break, 2 make auxiliary contacts

AC	SE00-11-PKZ0(...)	SE00-20-PKZ0(...)	S00-11-PKZ0(...)	S00-20-PKZ0(...)
	Article no. ¹⁾	Article no. ¹⁾	Article no. ¹⁾	Article no. ¹⁾
Standard voltage	See price list	See price list	See price list	See price list
24 V 50 Hz	072860	072828	072784	072752
48 V 50 Hz	072861	072829	072785	072753
240V 50Hz	072862	072830	072786	072754
24 V 60 Hz	072864	072832	072788	072756
110 V 60 Hz	072865	072833	072789	072757
115 V 60 Hz	072866	072834	072790	072758
42V 50Hz, 48 V 60 Hz	063317	063584	063334	063343
110V 50Hz, 120 V 60 Hz	063318	063326	063335	063344
190V 50Hz, 220 V 60 Hz	063319	063327	063336	063345
220V 50Hz, 240 V 60 Hz	063320	063328	063337	063346
230V 50Hz, 240 V 60 Hz	063321	063329	063338	063347
380V 50Hz, 440 V 60 Hz	063322	063330	063339	063348
400V 50Hz, 440 V 60 Hz	063323	063331	063340	063349
415V 50Hz, 480 V 60 Hz	063324	063332	063341	063350
24 V 50/60 Hz	072884	072845	072808	052579
42 V 50/60 Hz	072885	072846	072809	053385
110 V 50/60 Hz	072887	072848	072811	052578
230 V 50/60 Hz	063325	063333	063342	063351
DC				
Standard voltage	See price list	See price list	See price list	See price list
12 V DC	072822	072816	072746	072740
24 V DC	072823	072817	072747	072741
48 V DC	072824	072818	072748	072742
60V DC	072825	072819	072749	072743
110V DC	072826	072820	072750	072744
220V DC	072827	072821	072751	072745

Notes

¹⁾ The article no. is formed from the combination of type and actuating voltage.
Devices with **dual-voltage coils** must be ordered using **one** order number.



Moeller HPL0211-2004/2005

Compact starter

Contact modules with 1 make/1 break auxiliary contact

AC	PKZ2/ZM-1/ SE1A/11(...)	PKZ2/ZM-1,6/ SE1A/11(...)	PKZ2/ZM-2,4/ SE1A/11(...)	PKZ2/ZM-4/ SE1A/11(...)	PKZ2/ZM-6/ SE1A/11(...)
	Article no. ¹⁾	Article no. ¹⁾	Article no. ¹⁾	Article no. ¹⁾	Article no. ¹⁾
Standard voltage	See price list	See price list	See price list	See price list	See price list
24 V 50 Hz	058902	058922	058942	058962	058982
48 V 50 Hz	058904	058924	058944	058964	058984
240V 50Hz	058909	058929	058949	058969	058989
24 V 60 Hz	058903	058923	058943	058963	058983
110V 50Hz, 120 V 60 Hz	063362	063370	063380	063390	063400
190V 50Hz, 220 V 60 Hz	063363	063371	063381	063391	063401
220V 50Hz, 240 V 60 Hz	063367	063375	063385	063395	063405
230V 50Hz, 240 V 60 Hz	063364	063372	063382	063392	063402
380V 50Hz, 440 V 60 Hz	063368	063376	063386	063396	063406
400V 50Hz, 440 V 60 Hz	063365	063373	063383	063393	063403
415V 50Hz, 480 V 60 Hz	063366	063374	063384	063394	063404
24 V 50/60 Hz	063585	063377	063387	063397	063407
110 V 50/60 Hz	063586	063378	063388	063398	063408
230 V 50/60 Hz	063369	063379	063389	063399	063409
Non-standard voltages with the exception of the given standard voltages ²⁾ .	See price list	See price list	See price list	See price list	See price list
...V 50Hz (24 – 600V)	907517	908149	908151	907523	908153
...V 60Hz (24 – 600V)	907518	908150	908152	907524	908154

Notes

- ¹⁾ The article no. is formed from the combination of type and actuating voltage. Devices with **dual-voltage coils** must be ordered using **one** order number.
- ²⁾ With non-standard voltages the required actuating voltage from the defined range (...-...V) must be stated.



Compact starter

Contact modules with 1 make/1 break auxiliary contact

AC	PKZ2/ZM-10/ SE1A/11(...)	PKZ2/ZM-16/ SE1A/11(...)	PKZ2/ZM-25/ SE1A/11(...)	PKZ2/ZM-32/ SE1A/11(...)	PKZ2/ZM-40/ SE1A/11(...)	PKZ2/ SE1A/11(...)
	Article no. ¹⁾	Article no. ¹⁾	Article no. ¹⁾	Article no. ¹⁾	Article no. ¹⁾	Article no. ¹⁾
Standard voltage	See price list	See price list	See price list	See price list	See price list	See price list 183,00
24 V 50 Hz	059002	059022	059042	059062	059082	082063
48 V 50 Hz	059004	059024	059044	059064	059084	082064
240V 50Hz	059009	059029	059049	059070	059089	082137
24 V 60 Hz	059003	059023	059043	059063	059083	082138
110V 50Hz, 120 V 60 Hz	063410	063420	063430	063440	063450	082139
190V 50Hz, 220 V 60 Hz	063411	063421	063431	063441	063451	082140
220V 50Hz, 240 V 60 Hz	063415	063425	063435	063445	063455	082141
230V 50Hz, 240 V 60 Hz	063412	063422	063432	063442	063452	082142
380V 50Hz, 440 V 60 Hz	063416	063426	063436	063446	063456	082143
400V 50Hz, 440 V 60 Hz	063413	063423	063433	063443	063453	082144
415V 50Hz, 480 V 60 Hz	063414	063424	063434	063444	063454	082145
24 V 50/60 Hz	063417	063427	063437	063447	063457	082146
110 V 50/60 Hz	063418	063428	063438	063448	063458	082147
230 V 50/60 Hz	063419	063429	063439	063449	063459	082148
Non-standard voltages with the exception of the given standard voltages ²⁾ .	See price list	See price list	See price list	See price list	See price list	See price list 187,00 50
...V 50Hz (24 – 600V)	907505	907507	907509	907511	907513	982149
...V 60Hz (24 – 600V)	907506	907508	907510	907512	907514	982150

Notes

- ¹⁾ The article no. is formed from the combination of type and actuating voltage. Devices with **dual-voltage coils** must be ordered using **one** order number.
- ²⁾ With non-standard voltages the required actuating voltage from the defined range (...-...V) must be stated.



Moeller HPL0211-2004/2005

High-capacity compact starter
Contact modules with 1 make/1 break auxiliary contact

AC	PKZ2/ZM-1/ S(...)	PKZ2/ZM-1,6/ S(...)	PKZ2/ZM-2,4/ S(...)	PKZ2/ZM-4/ S(...)	PKZ2/ZM-6/ S(...)
	Article no. ¹⁾	Article no. ¹⁾	Article no. ¹⁾	Article no. ¹⁾	Article no. ¹⁾
Standard voltage	See price list	See price list	See price list	See price list	See price list
24 V 50 Hz	028981	000505	052711	076441	097798
48 V 50 Hz	059117	059110	059138	059159	059173
240V 50Hz	031402	031534	031616	031770	026869
24 V 60 Hz	059116	059109	059137	059158	059172
110V 50Hz, 120 V 60 Hz	063470	063480	063490	063500	063510
190V 50Hz, 220 V 60 Hz	063471	063481	063491	063501	063511
220V 50Hz, 240 V 60 Hz	063475	063485	063495	063505	063515
230V 50Hz, 240 V 60 Hz	063472	063482	063492	063502	063512
380V 50Hz, 440 V 60 Hz	063476	063486	063496	063506	063516
400V 50Hz, 440 V 60 Hz	063473	063483	063493	063503	063513
415V 50Hz, 480 V 60 Hz	063474	063484	063494	063504	063514
24 V 50/60 Hz	063477	063487	063497	063507	063517
110 V 50/60 Hz	063478	063488	063498	063508	063518
230 V 50/60 Hz	063479	063489	063499	063509	063519
Non-standard voltages with the exception of the given standard voltages ²⁾ .	See price list	See price list	See price list	See price list	See price list
...V 50Hz (24 – 600V)	907495	907497	907499	907501	907503
...V 60Hz (24 – 600V)	907496	907498	907500	907502	907504

Notes

- ¹⁾ The article no. is formed from the combination of type and actuating voltage. Devices with **dual-voltage coils** must be ordered using **one** order number.
- ²⁾ With non-standard voltages the required actuating voltage from the defined range (...-...V) must be stated.



High-capacity compact starter

Contact modules with 1 make/1 break auxiliary contact

AC	PKZ2/ZM-10/ S(...)	PKZ2/ZM-16/ S(...)	PKZ2/ZM-25/ S(...)	PKZ2/ZM-32/ S(...)	PKZ2/ZM-40/ S(...)	PKZ2/S(...)
	Article no. ¹⁾	Article no. ¹⁾	Article no. ¹⁾	Article no. ¹⁾	Article no. ¹⁾	Article no. ¹⁾
Standard voltage	See price list	See price list	See price list	See price list	See price list	See price list 201,00 50
24 V 50 Hz	095146	076165	073793	076167	002607	063580
48 V 50 Hz	059124	059131	059145	059152	059166	063581
240V 50Hz	027021	027125	027519	028717	029051	063582
24 V 60 Hz	059123	059130	059144	059151	059165	063583
110V 50Hz, 120 V 60 Hz	063520	063530	063540	063550	063560	063570
190V 50Hz, 220 V 60 Hz	063521	063531	063541	063551	063561	063571
220V 50Hz, 240 V 60 Hz	063525	063535	063545	063555	063565	063575
230V 50Hz, 240 V 60 Hz	063522	063532	063542	063552	063562	063572
380V 50Hz, 440 V 60 Hz	063526	063536	063546	063556	063566	063576
400V 50Hz, 440 V 60 Hz	063523	063533	063543	063553	063563	063573
415V 50Hz, 480 V 60 Hz	063524	063534	063544	063554	063564	063574
24 V 50/60 Hz	063527	063537	063547	063557	063567	063577
110 V 50/60 Hz	063528	063538	063548	063558	063568	063578
230 V 50/60 Hz	063529	063539	063549	063559	063569	063579
Non-standard voltages with the exception of the given standard voltages ²⁾ .	See price list	See price list	See price list	See price list	See price list	See price list 205,00 50
...V 50Hz (24 – 600V)	907491	907489	907487	907485	907483	907481
...V 60Hz (24 – 600V)	907492	907490	907488	907486	907484	907482

Notes

- ¹⁾ The article no. is formed from the combination of type and actuating voltage.
Devices with **dual-voltage coils** must be ordered using **one** order number.
- ²⁾ With non-standard voltages the required actuating voltage from the defined range (...-...V) must be stated.



Moeller HPL0211-2004/2005

Undervoltage release						
AC	When ordered with basic unit			When ordered separately		
	+U-PKZ2(...)	+U-HI20-PKZ2(...)	+UVHI-PKZ2(...)	U-PKZ2(...)	U-HI20-PKZ2(...)	UVHI-PKZ2(...)
	Article no. ¹⁾	Article no. ¹⁾	Article no. ¹⁾	Article no. ¹⁾	Article no. ¹⁾	Article no. ¹⁾
Standard voltage	See price list	See price list	See price list	See price list	See price list	See price list
24 V 50 Hz	062204	063621	071321	055085	063649	073694
48 V 50 Hz	012050	063622	012083	023955	063650	000226
240V 50Hz	099850	063623	066661	009717	063652	090399
208/220 V 60 Hz	063611	063625	063636	063632	063654	063663
110V 50Hz, 120 V 60 Hz	063612	063626	063637	065686	063655	063664
220V 50Hz, 240 V 60 Hz	063613	063627	063638	065685	063656	063665
230V 50Hz, 240 V 60 Hz	065760	065762	065764	065766	065768	065770
380V 50Hz, 440 V 60 Hz	063614	063628	063639	065689	063657	063666
400V 50Hz, 440 V 60 Hz	065761	065763	065765	065767	065769	065771
415V 50Hz, 480 V 60 Hz	063615	063629	063640	065684	063658	063667
24 V 50/60 Hz	063616	063630	063641	063646	063659	063668
48 V 50/60 Hz	063617	063631	063642	063647	063660	063669
Non-standard voltages with the exception of the given standard voltages ²⁾ .	See price list	See price list	See price list	See price list	See price list	See price list
...V 50Hz (24 – 600V)	908155	907531	907533	908157	907537	907539
...V 60Hz (24 – 600V)	908156	907532	907534	908158	907538	907540
DC						
Standard voltage	See price list	See price list	See price list	See price list	See price list	See price list
24 V DC	002558	–	–	014463	–	–
48 V DC	059510	–	–	028701	–	–
60V DC	050059	–	–	035820	–	–
110/125V DC	063620	–	–	063648	–	–

Notes

- ¹⁾ The article no. is formed from the combination of type and actuating voltage. Devices with **dual-voltage coils** must be ordered using **one** order number.
²⁾ With non-standard voltages the required actuating voltage from the defined range (...-...V) must be stated.



Remote operator		
AC, DC	RE-PKZ2(...)	RS-PKZ2(...)
	Article no. ¹⁾	Article no. ¹⁾
Standard voltage	See price list	See price list
24 V, 50/60 Hz, DC	063670	063682
42 V, 50/60 Hz, DC	063671	063683
48 V, 50/60 Hz, DC	063672	063684
110 – 120 V 50/60 Hz, DC	063673	063685
120 – 130 V 50/60 Hz, DC	063674	063686
190 – 220 V 50/60 Hz, DC	063675	063687
220 – 240 V 50/60 Hz, DC	063676	063688
Non-standard voltage with the exception of the mentioned standard voltages	See price list	See price list
60 V 50/60 Hz, DC	063679	063691
100 V, 50/60 Hz, DC	063680	028912
170 – 190 V 50/60 Hz, DC	063681	063693
AC		
Standard voltage	See price list	See price list
380 – 415 V 50/60 Hz	063677	063689
Non-standard voltages	See price list	See price list
440 V 50/60 Hz	063678	063690

Notes

¹⁾ The article no. is formed from the combination of type and actuating voltage.



Moeller HPL0211-2004/2005

(High-capacity) contact module
individual coil for (high-capacity) contact module

AC	S-PKZ2(...)	S/HI20-S-PKZ2(...)	SE1A/11-PKZ2(...)	SE1A/20-PKZ2(...)	J-S-PKZ2(...) Individual coil
	Article no. ¹⁾	Article no. ¹⁾	Article no. ¹⁾	Article no. ¹⁾	Article no. ¹⁾
Standard voltage	See price list	See price list	See price list	See price list	See price list
24 V 50 Hz	026609	056378	058722	058723	035726
48 V 50 Hz	062651	056383	058742	058743	065114
240V 50Hz	001882	057048	058716	058717	065126
24 V 60 Hz	062501	056380	058724	058725	065111
110V 50Hz, 120 V 60 Hz	063694	063701	063709	063716	063723
190V 50Hz, 220 V 60 Hz	063695	063702	063710	063717	063724
220V 50Hz, 240 V 60 Hz	063699	063706	063714	063721	063728
230V 50Hz, 240 V 60 Hz	063696	063703	063711	063718	063725
380V 50Hz, 440 V 60 Hz	063700	063707	063715	063722	063729
400V 50Hz, 440 V 60 Hz	063697	063704	063712	063719	063726
415V 50Hz, 480 V 60 Hz	063698	063705	063713	063720	063727
24 V 50/60 Hz	062500	056379	058720	058721	065110
110 V 50/60 Hz	063063	056385	058696	058697	065116
230 V 50/60 Hz	065103	056395	058712	058713	065125
Non-standard voltages with the exception of the given standard voltages ²⁾ .	See price list	See price list	See price list	See price list	See price list
...V 50Hz (24 – 600V)	907541	907543	907545	907547	907549
...V 60Hz (24 – 600V)	907542	907544	907546	907548	907550
DC	S-G-PKZ2(...)	SE1A-G-10-PKZ2(...)			
	Article no. ¹⁾	Article no. ¹⁾			
Standard voltage	See price list	See price list			
24 V DC	070921	058856			
110V DC	218934	218935			
125V DC	203583	203582			

Notes

- ¹⁾ The article no. is formed from the combination of type and actuating voltage.
Devices with **dual-voltage** coils must be ordered using **one** order number.
- ²⁾ With non-standard voltages the required actuating voltage from the defined range (...-...V) must be stated.



S00-PKZ0 high-capacity contact module, SE00-PKZ0 contact module

Normal switching duty

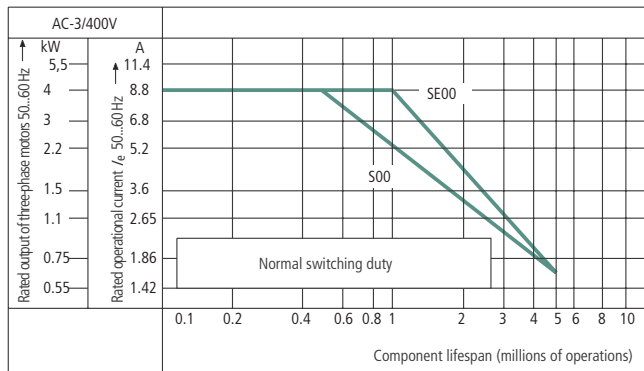

Squirrel-cage motor

Operating characteristics: Starting: From rest
Stopping: At full operating speed

Typical applications: Compressors Lifts Mixers
Pumps Escalators Agitators
Fans Conveyors Centrifuges
Valves Bucket-elevator Air-conditioning systems

General drives for manufacturing processing machines

Electrical characteristics: Starting: Up to 6 × rated motor current
Stopping: 1 × rated motor current

Utilization category: 100 % AC-3

Extreme switching duty

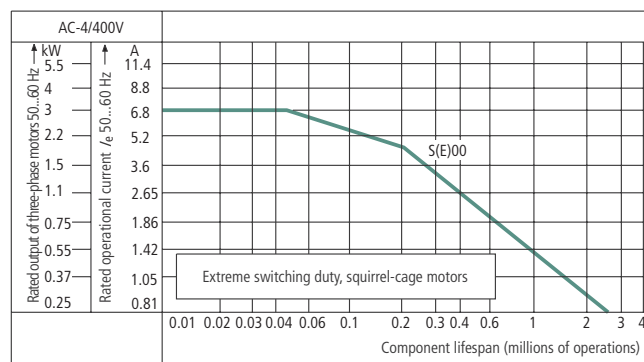

Squirrel-cage motor

Operating characteristics: Inching, plugging, reversing

Typical applications: Printing machines
Wire-drawing machine
Centrifuge
Special drives for manufacturing and processing machines

Electrical characteristics: Starting: 6 × rated motor current
Stopping: 6 × rated motor current

Utilization category: 100 % AC-4

Light switching duty

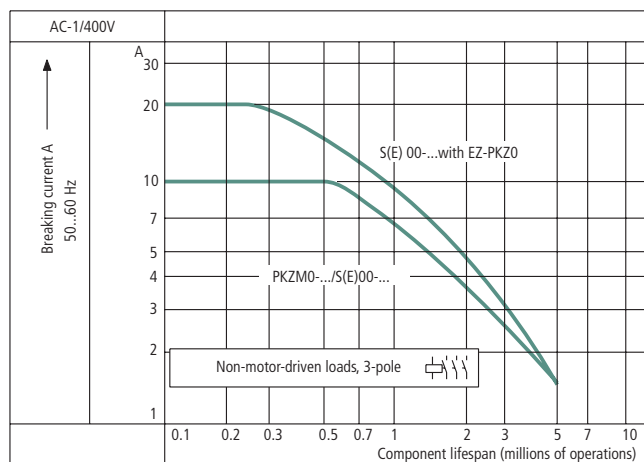

Non-motor loads

Operating characteristics: Non-inductive or slightly inductive loading

Typical applications: Electric heat

Electrical characteristics: Starting: Up to 1.5 × rated motor current
Stopping: 1 × rated motor current

Utilization category: 100 % AC-1

Determination of the maximum operating frequency dependant on the rating and utilization category (recommended values) for (high-capacity) contact modules

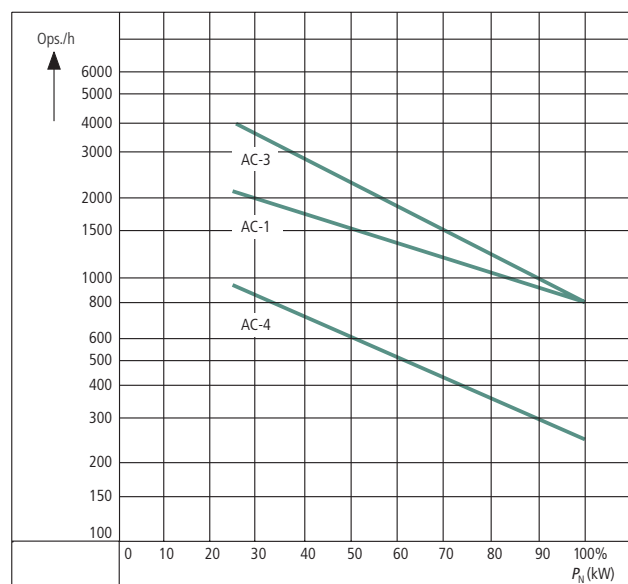

P_N = max. motor rating (kW) of the contactor concerned
S/h = max. operation per hour

Moeller HPL0211-2004/2005

Motor-protective circuit-breaker tripping characteristic (high-capacity) compact starter, PKZM0-...T (not for PKM0-...), PKZM01

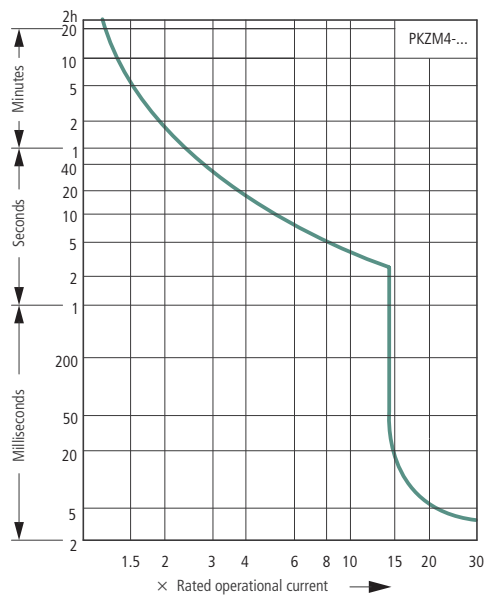
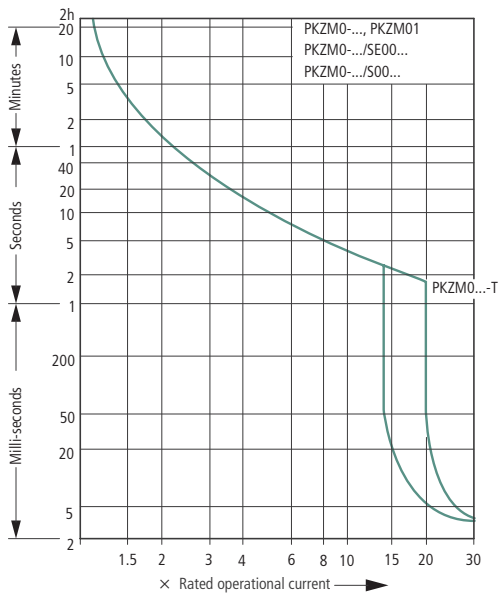

Let-through characteristics, motor-protective circuit-breaker, transformer-protective circuit-breaker, circuit-breaker for starter combinations

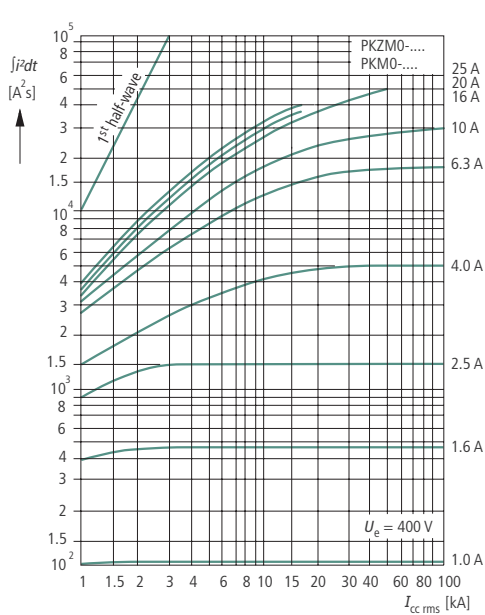
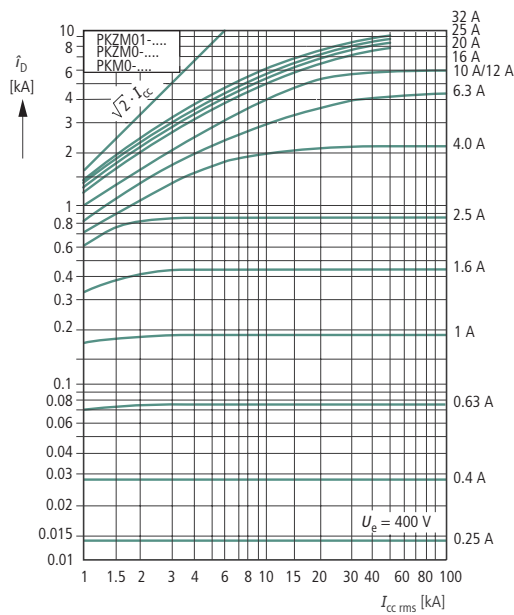

Let-through characteristics (high-capacity) compact starter

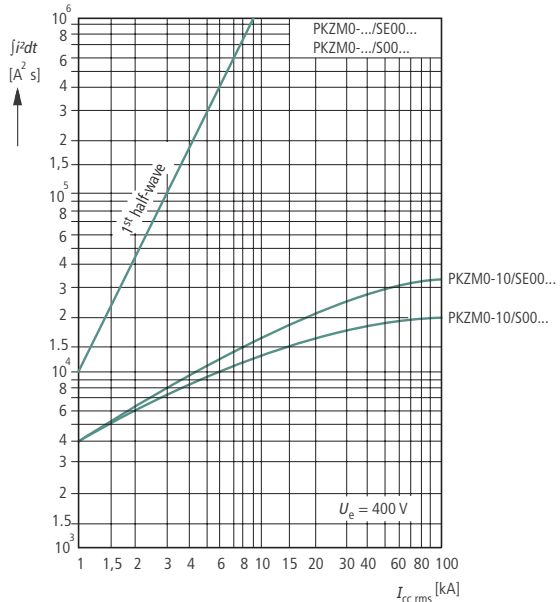
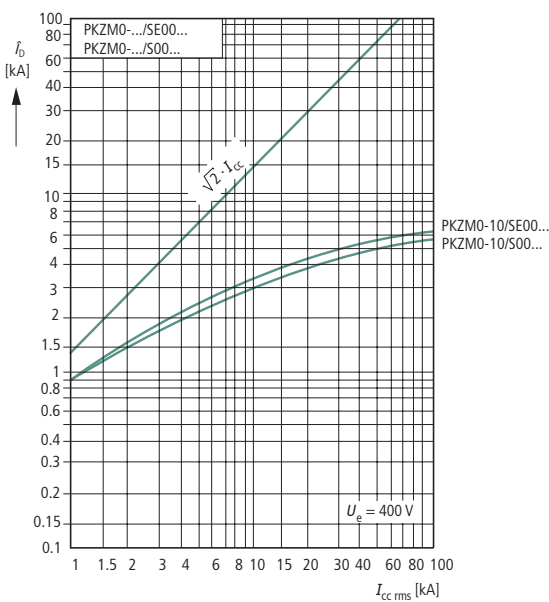

Motor-protective circuit-breaker let-through characteristics

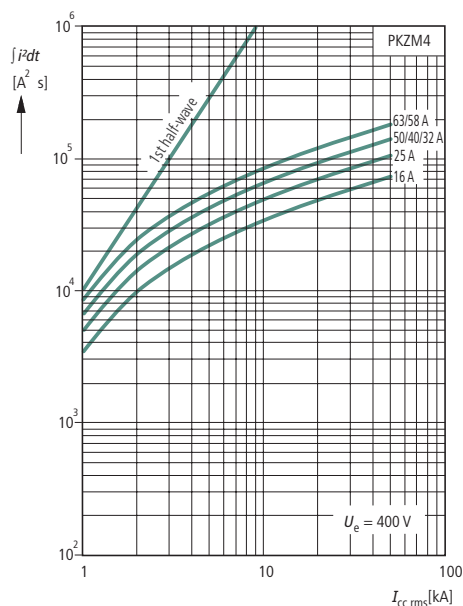
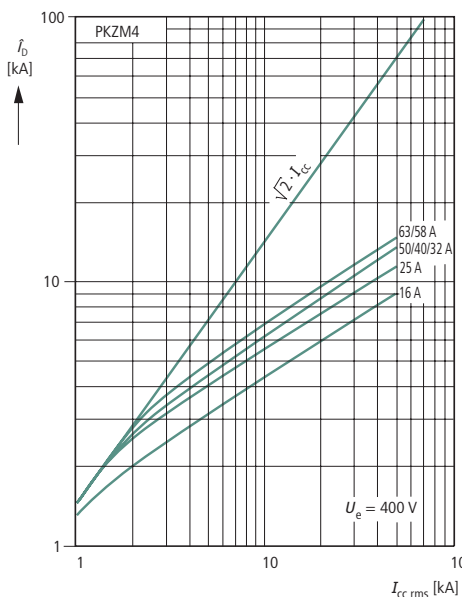

Circuit-breaker switching capacity

Rated uninterrupted current I_u
 Rated conditional short-circuit current I_q IEC/EN 60947-4-1
 Rated ultimate short-circuit breaking capacity I_{cu}
 Rated operational short-circuit breaking capacity I_{cs} } IEC/EN 60947-2

I_u A	230 V				400 V				440 V				500 V				690 V			
	I_q kA	I_{cu} kA	I_{cs} kA	A ¹⁾	I_q kA	I_{cu} kA	I_{cs} kA	A ¹⁾	I_q kA	I_{cu} kA	I_{cs} kA	A ¹⁾	I_q kA	I_{cu} kA	I_{cs} kA	A ¹⁾	I_q kA	I_{cu} kA	I_{cs} kA	A ¹⁾

PKZM01 with classification type "1" and "2"

0.16 - 1	50	50	50	50	50	50	50	50	50	50	50	50	50	50	50	50	50	50	50	50	
1.6	50	50	50	50	50	50	50	50	50	50	50	50	50	50	50	50	50	50	50	50	
2.5	50	50	50	50	50	50	50	50	50	50	50	50	50	50	50	50	50	50	50	50	
4	50	50	50	50	50	50	50	50	50	50	50	50	50	50	50	50	50	50	50	50	
6.3	50	50	50	50	50	50	50	50	50	50	50	50	50	50	50	50	50	50	50	50	
10	50	50	50	50	50	50	50	50	50	42	42	10	50	42	42	10	50	42	42	10	50
12	50	50	50	50	50	50	10	50	15	15	10	50	15	15	10	50	15	15	10	50	

PKZM4 with classification type "1" and "2"

16	150	150	25	N	150	150	25	N	45	45	25	100	15	15	100	8	8	2.5	100
25	150	150	25	N	150	150	25	N	45	45	25	100	15	15	100	8	8	2.5	100
32	50	50	25	100	50	50	25	100	45	45	25	100	15	15	100	5	5	2.5	100
40	50	50	25	100	50	50	25	100	45	45	25	100	15	15	100	5	5	2.5	100
50	50	50	25	100	50	50	25	100	45	45	25	100	15	15	100	5	5	2.5	100
58	50	50	25	160	50	50	25	160	45	45	25	160	15	15	160	5	5	2.5	160
63	50	50	25	160	50	50	25	160	45	45	25	160	15	15	160	5	5	2.5	160

Notes

■ No upstream protective device required, as it is the auto-protected range (150 kA)
 N Not required

¹⁾ Fuse (A gG/gL) for enhancing the switching capacity of the motor-protective circuit-breaker to 100 kA

Moeller HPL0211-2004/2005

Circuit-breaker switching capacity from serial no. 04

Rated uninterrupted current I_u

Rated conditional short-circuit current I_q IEC/EN 60947-4-1

Rated ultimate short-circuit breaking capacity I_{cu}

Rated operational short-circuit breaking capacity I_{cs} } IEC/EN 60947-2

I_u A	230 V				400 V				440 V				500 V				690 V			
	I_q kA	I_{cu} kA	I_{cs} kA	A ¹⁾	I_q kA	I_{cu} kA	I_{cs} kA	A ¹⁾	I_q kA	I_{cu} kA	I_{cs} kA	A ¹⁾	I_q kA	I_{cu} kA	I_{cs} kA	A ¹⁾	I_q kA	I_{cu} kA	I_{cs} kA	A ¹⁾

PKZM0, PKZM0...-T, PKM0 with classification type "1" and "2"

0.16 – 1	150	150	150	N	150	150	150	N				N				N				N
1.6	150	150	150	N	150	150	150	N				N				N				N
2.5	150	150	150	N	150	150	150	N				N				N	5	5	5	50
4	150	150	150	N	150	150	150	N				N				N	3	3	3	50
6.3	150	150	150	N	150	150	150	N				N	42	42	6	50	3	3	2	50
10	150	150	150	N	150	150	150	N	42	42	10	50	42	42	6	50	3	3	2	50
12	50	50	10	50	50	50	10	50	15	15	10	50	15	15	6	50	3	3	2	50
16	50	50	10	50	50	50	10	50	15	15	10	50	15	15	6	50	3	3	2	50
20	50	50	10	50	50	50	10	50	10	10	10	50	6	6	6	50	3	3	2	50
25	50	50	10	50	50	50	10	50	10	10	10	50	6	6	6	50	3	3	2	50
32	50	50	10	50	50	50	10	50	10	10	10	50	6	6	6	50	3	3	2	50

PKZM0 (PKZM0...-T, PKM0) + CL-PKZO

0.16 – 1				N				N				N							20	N
1.6				N				N				N							20	N
2.5				N				N				N					20	20	20	N
4				N				N				N					20	20	20	N
6.3				N				N				N			50	N	20	20	20	N
10				N				N				N			20	N	20	20	20	N
12				N				N				N			20	N	5	5	2.5	N
16				N				N				N			20	N	5	5	2.5	N
20				N				N				N	10	10	10	N	5	5	2.5	N
25				N				N				N	10	10	10	N	5	5	2.5	N
32				N				N				N	10	10	10	N	5	5	2.5	N

PKZM0 (PKZM0...-T, PKM0) + 2 CL-PKZO

0.16 – 1				N				N				N							20	N
1.6				N				N				N							20	N
2.5				N				N				N					40	40	20	N
4				N				N				N					40	40	20	N
6.3				N				N				N			50	N	20	20	20	N
10				N				N				N			40	N	20	20	20	N
12				N				N				N			40	N	10	10	2.5	N
16				N				N				N			40	N	10	10	2.5	N
20				N				N				N	20	20	20	N	10	10	2.5	N
25				N				N				N	20	20	20	N	10	10	2.5	N
32				N				N				N	20	20	20	N	10	10	2.5	N

PKZM0.../SE00... with classification type "1"; PKZM0.../S00... with classification type "1" and "2"

0.16 – 1		N	N	N		N	N	N		N	N	N		N	N	N		N	N	N
1.6		N	N	N		N	N	N		N	N	N		N	N	N		N	N	N
2.5		N	N	N		N	N	N		N	N	N		N	N	N	5	N	N	50
4		N	N	N		N	N	N		N	N	N		N	N	N	5	N	N	50
6.3		N	N	N		N	N	N		N	N	N	6	N	N	50	3	N	N	50
10		N	N	N		N	N	N		N	N	N	6	N	N	50	3	N	N	50

Notes

■ No upstream protective device required, as it is the auto-protected range (100/150 kA)
 N Not required

¹⁾ Required back-up fuse if the short-circuit current exceeds the rated conditional short-circuit current ($I_{cc} > I_q$).



Moeller HPL0211-2004/2005

Moeller HPL0211-2004/2005

		PKZM01...	PKZM0-...	PKM0-...
General				
Standards		IEC/EN 60947, VDE 0660, UL 508, CSA C 22.2 No. 14		
Climatic proofing		Damp heat, constant, to IEC 60068-2-78 Damp heat, cyclic, to IEC 60068-2-30		
Ambient temperature	Storage	°C	-25/80	-25/80
	Open	°C	-25/55	-25/55
	Enclosed	°C	-25/40	-25/40
Mounting position				
Direction of incoming supply		As required		
Degree of protection	Device	IP20	IP20	IP20
	Terminals	IP00	IP00	IP00
Protection against direct contact		Finger- and back-of-hand proof		
Shock resistance half-sinusoidal shock 10 ms to IEC 60068-2-27		g	25	25
Altitude		m	max.2000	max.2000
Terminal capacity	Solid	mm ²	1 × (1-6) 2 × (1-6)	1 × (1-6) 2 × (1-6)
	Flexible with ferrule to DIN 46228	mm ²	1 × (1-6) 2 × (1-6)	1 × (1-6) 2 × (1-6)
	Solid or stranded	AWG	18-10	18-10
Terminal screw tightening torque				
Main cable		Nm	1.7	1.7
Control circuit cable		Nm	1	1
Main contacts				
Rated impulse withstand voltage		U_{imp}	V AC	6000
Overvoltage category/pollution degree			III/3	III/3
Rated operational voltage		U_e	V AC	690
Rated uninterrupted current = rated operational current		$I_u = I_e$	A	16 or current setting of the overcurrent release
Rated frequency		Hz	40-60	40-60
Current heat loss (3-pole at operating temperature)		W	6	6
Lifespan, mechanical		Operations	× 10 ⁶	0.05
Lifespan, electrical (AC-3 at 400 V)		Operations	× 10 ⁶	0.05
Maximum operating frequency		Operations/h	Ops/h	25
Short-circuit rating				
AC			kA	→ page 8/71
DC			kA	60
Motor switching capacity AC-3 (up to 690 V)		A		16
DC-5 (up to 250 V)		A		16 (3 contacts in series)
Releases				
Temperature compensation to IEC/EN 60947, VDE 0660		°C		-5/40
Operating range		°C		-25/55
Temperature compensation residual error for T > 20 °C		%/K		≤0.25
Overload release setting ranger		× I_u		0.6-1
Fixed short-circuit release		× I_u		14
Short-circuit release tolerance		%		±20
Phase-failure sensitivity				IEC/EN 60947-1-1, VDE 0660 Part 102

PKZM0-...-T	PKZM0-.../S(E)00-...	SE00-...	S00-...	PKZM4
IEC/EN 60947, VDE 0660, UL 508, CSA C 22.2 No. 14				
Damp heat, constant, to IEC 60068-2-78 Damp heat, cyclic, to IEC 60068-2-30				
°C	°C	°C	°C	°C
-25/80	-25/70	-25/70	-25/70	-25/70
-25/55	-25/55	-25/55	-25/55	-25/55
-25/40	-25/40	-25/40	-25/40	-25/40
Direction of incoming supply		From above		As required
Degree of protection		IP20	IP20	IP20
Protection against direct contact		Finger- and back-of-hand proof		
Shock resistance half-sinusoidal shock 10 ms to IEC 60068-2-27		g	25	25
Altitude		m	max.2000	max.2000
Terminal capacity	Solid	mm ²	1 × (1-6) 2 × (1-6)	1 × (1-6) 2 × (1-6)
	Flexible with ferrule to DIN 46228	mm ²	1 × (1-6) 2 × (1-6)	1 × (1-6) 2 × (1-6)
	Solid or stranded	AWG	18-10	18-10
Terminal screw tightening torque				
Main cable		Nm	1.7	1.7
Control circuit cable		Nm	1	1
Rated impulse withstand voltage		U_{imp}	V AC	6000
Overvoltage category/pollution degree			III/3	III/3
Rated operational voltage		U_e	V AC	690
Rated uninterrupted current = rated operational current		$I_u = I_e$	A	16 or current setting of the overcurrent release
Rated frequency		Hz	40-60	40-60
Current heat loss (3-pole at operating temperature)		W	6	6
Lifespan, mechanical		Operations	× 10 ⁶	0.05
Lifespan, electrical (AC-3 at 400 V)		Operations	× 10 ⁶	0.05
Maximum operating frequency		Operations/h	Ops/h	25
Short-circuit rating				
AC			kA	→ page 8/71
DC			kA	60
Motor switching capacity AC-3 (up to 690 V)		A		16
DC-5 (up to 250 V)		A		16 (3 contacts in series)
Temperature compensation to IEC/EN 60947, VDE 0660		°C		-5/40
Operating range		°C		-25/55
Temperature compensation residual error for T > 20 °C		%/K		≤0.25
Overload release setting ranger		× I_u		0.6-1
Fixed short-circuit release		× I_u		14
Short-circuit release tolerance		%		±20
Phase-failure sensitivity				IEC/EN 60947-1-1, VDE 0660 Part 102



					PKZM0-.../S(E)00-...	S(E)00	
Magnet systems							
AC operation							
Operating range	Single-voltage coil 50 Hz and dual-voltage coil 50 Hz, 60 Hz	Pick-up	$\times U_s$		0.85 – 1.1	0.85 – 1.1	
	Single-voltage coil 50 Hz and dual-voltage coil 50 Hz, 60 Hz	Drop-out	$\times U_s$		0.4 – 0.6	0.4 – 0.6	
	Dual-frequency coil 50/60 Hz	Pick-up	$\times U_s$		0.85 – 1.1	0.85 – 1.1	
	Dual-frequency coil 50/60 Hz	Drop-out	$\times U_s$		0.25 – 0.5	0.25 – 0.5	
Power consumption	Single-voltage coil 50 Hz and dual-voltage coil 50 Hz, 60 Hz	Pick-up	VA		25	25	
	Single-voltage coil 50 Hz and dual-voltage coil 50 Hz, 60 Hz	Pick-up	W		22	22	
	Single-voltage coil 50 Hz and dual-voltage coil 50 Hz, 60 Hz	Sealing	VA		4.6	4.6	
	Single-voltage coil 50 Hz and dual-voltage coil 50 Hz, 60 Hz	Sealing	W		1.3	1.3	
	Dual-frequency coil 50/60 Hz at 50 Hz	Pick-up	VA		30	30	
	Dual-frequency coil 50/60 Hz at 50 Hz	Pick-up	W		26	26	
	Dual-frequency coil 50/60 Hz at 50 Hz	Sealing	VA		5.6	5.6	
	Dual-frequency coil 50/60 Hz at 50 Hz	Sealing	W		1.6	1.6	
	Dual-frequency coil 50/60 Hz at 60 Hz	Pick-up	VA		29	29	
	Dual-frequency coil 50/60 Hz at 60 Hz	Pick-up	W		24	24	
	Dual-frequency coil 50/60 Hz at 60 Hz	Sealing	VA		3.9	3.9	
	Dual-frequency coil 50/60 Hz at 60 Hz	Sealing	W		1.1	1.1	
	Switching times at 100 % U_s (main contact)	Closing delay		ms		14 – 21	14 – 21
		Opening delay		ms		8 – 18	8 – 18
DC operation							
Operating range	Pick-up voltage		$\times U_s$		0.85 – 1.1	0.85 – 1.1	
Power consumption pull-in = sealing				VA/W	2.6	2.6	
Switching times at 100 % U_s (main contact)	Closing delay		ms		26 – 35	26 – 35	
	Opening delay		ms		15 – 20	15 – 20	
Duty factor			% DF		100	100	
Main contacts							
Rated making capacity $\cos \varphi = 0.45$, 230 - 690 V AC				A	110	110	
Rated breaking capacity	$\cos \varphi = 0.45$, 230 V AC			A	90	90	
	$\cos \varphi = 0.45$, 400 V AC			A	90	90	
	$\cos \varphi = 0.45$, 500 V AC			A	64	64	
	$\cos \varphi = 0.45$, 690 V AC			A	54	54	
Rated operational current enclosed, open							
AC-1 operation	230 V	I_e	A		9	16	
	400 V	I_e	A		9	16	
	440 V	I_e	A		9	16	
	500 V	I_e	A		9	16	
	690 V	I_e	A		9	16	
AC-3 operation	230 V	I_e	A		8.8	8.7	
	400 V	I_e	A		8.8	8.8	
	440 V	I_e	A		7.7	7.7	
	500 V	I_e	A		6.4	6.4	
	690 V	I_e	A		4.8	4.8	
AC-4 operation	230 V	I_e	A		6.6	6.6	
	400 V	I_e	A		6.6	6.6	
	440 V	I_e	A		6	6	
	500 V	I_e	A		5	5	
	690 V	I_e	A		3.4	3.4	
					CL-PKZ0		
Current limiter							
Rated impulse withstand voltage		U_{imp}	V AC		6000		
Overvoltage category/pollution degree					III/3		
Rated operational voltage		U_e	V AC		690		
Rated uninterrupted current		I_u	A		63		



Moeller HPL0211-2004/2005

			NHI...PKZ0	NHI-E-...PKZ0	NHI...S-PKZ0	VHI...PKZ0	AGM
Auxiliary contacts							
Rated impulse withstand voltage	U_{imp}	V AC	6000	4000	6000	4000	6000
Overvoltage category/pollution degree			III/3	III/3	III/3	III/3	III/3
Rated operational voltage	U_e	V AC	500	440	500	440	500
	U_e	V DC	250	250	250	250	250
Safe isolation to VDE 0106 Part 101 and Part 101/A1							
Between auxiliary contacts and main contacts		V AC	690	690	690	690	690
Rated operational current							
AC-15							
220 – 240 V	I_e	A	3.5	1	3.5	1	3.5
380 – 415 V	I_e	A	2	–	2	–	2
440 – 500 V	I_e	A	1	–	1	–	1
DC-13 L/R ≤ 100 ms							
24 V	I_e	A	2	–	2	–	2
60 V	I_e	A	1.5	–	1.5	–	1.5
110 V	I_e	A	1	–	1	–	1
220 V	I_e	A	0.25	–	0.25	–	0.25
Lifespan							
Lifespan, mechanical	Operations	$\times 10^6$	> 0.1	> 0.1	> 5	> 0.1	> 0.01
Lifespan, electrical	Operations	$\times 10^6$	> 0.05	> 0.1	> 1	> 0.1	> 0.005
Contact reliability (at $U_e = 24$ V DC, $U_{min} = 17$ V, $I_{min} = 5.4$ mA)	Fault probability	λ	< 10^{-8} < 1 fault at 1×10^8 operations				
Positively driven contacts to ZH 1/457			Yes	–	Yes	–	–
Short-circuit rating without welding							
Fuseless			FAZ-B4/1-HI	–	FAZ-B4/1-HI	–	FAZ-B4/1-HI
Fuse		A gG/gL	10	10	10	10	10
Terminal capacity							
Solid or flexible conductor with ferrule		mm ²	0.75 – 2.5	0.75 – 1.5	0.75 – 2.5	0.75 – 1.5	0.75 – 2.5
Solid or stranded		AWG	18 – 14	18 – 16	18 – 14	18 – 16	18 – 14



					U-PKZ...
Undervoltage release					
Cross-sections	Solid or flexible conductor with ferrule		mm ²		1 × (0.75 – 2.5) 2 × (0.75 – 2.5)
	Solid or stranded		AWG		1 × (18 – 14) 2 × (18 – 14)
Main contacts					
Rated operational voltage		U_e	V AC		42 – 480
Rated operational voltage		U_e	V DC		24 – 250
Pick-up voltage		$\times U_s$			0.85 – 1.1
Drop-out voltage		$\times U_s$			0.7 – 0.35
Power consumption	Pick-up AC	Pick-up	VA		5
	Sealing AC	Sealing	VA		3

					A-PKZ...
Shunt release					
Cross-sections	Solid or flexible conductor with ferrule		mm ²		1 × (0.75 – 2.5) 2 × (0.75 – 2.5)
	Solid or stranded		AWG		1 × (18 – 14) 2 × (18 – 14)
Main contacts					
Rated operational voltage		U_e	V AC		42 – 480
Rated operational voltage		U_e	V DC		24 – 250
Operating range	AC		$\times U_s$		0.7 – 1.1
	DC voltage (intermittent operation 5 s)		$\times U_s$		0.7 – 1.1
Power consumption	AC	Pick-up AC	Pick-up	VA	5
		Sealing AC	Sealing	VA	3
	DC	DC pick-up rating	Pick-up	W	3
		Sealing DC	Sealing	W	3



Moeller HPL0211-2004/2005

Motor-protective circuit-breaker (high-capacity) compact starter tripping characteristic

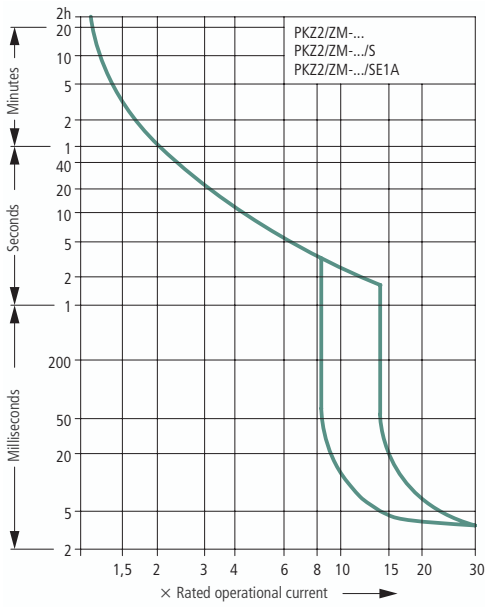

Cable and line protection tripping characteristic

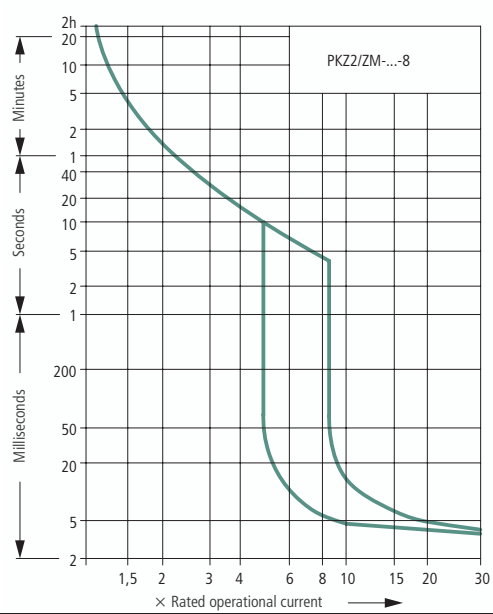

Circuit-breakers and compact starter let-through characteristics

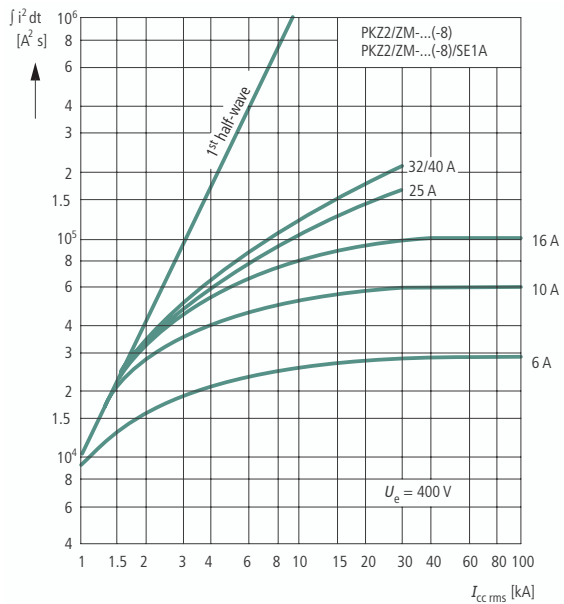
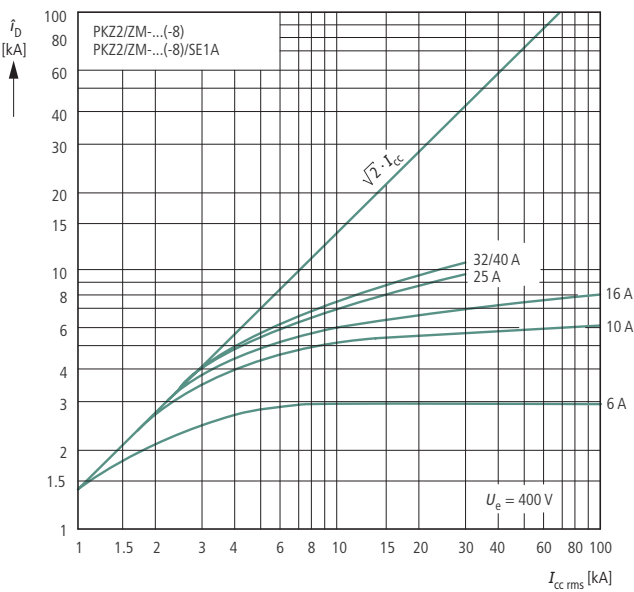

High-capacity compact starter and circuit-breaker + CL current limiter let-through characteristics

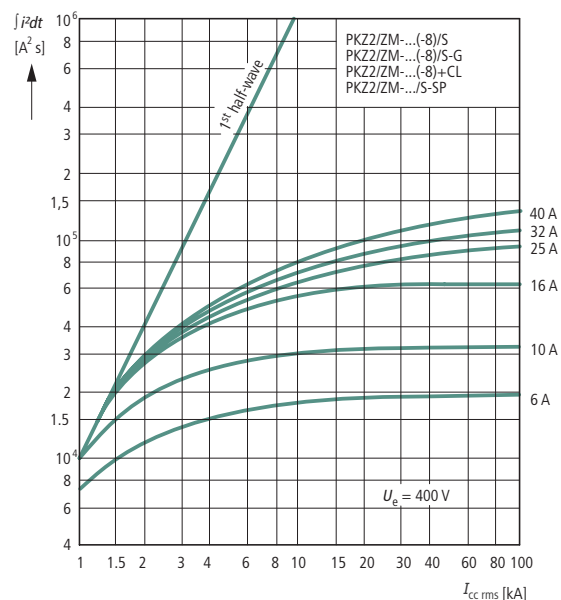
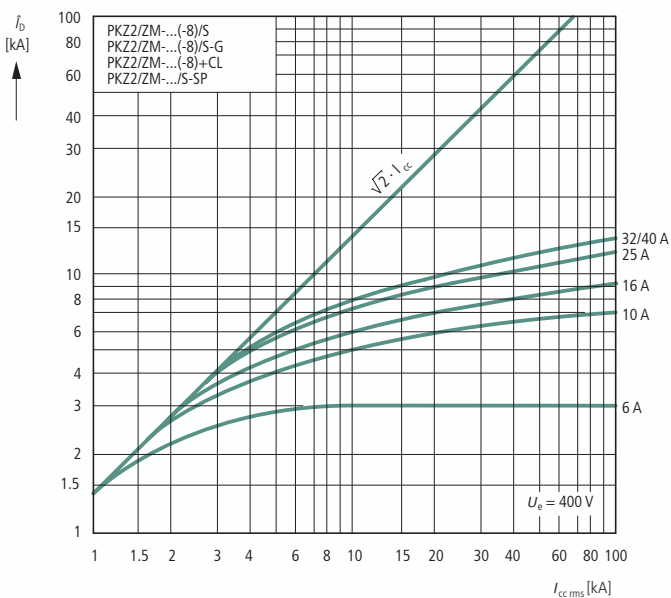

S-PKZ2 high-capacity contact module, SE1A-PKZ2 contact module

Normal switching duty

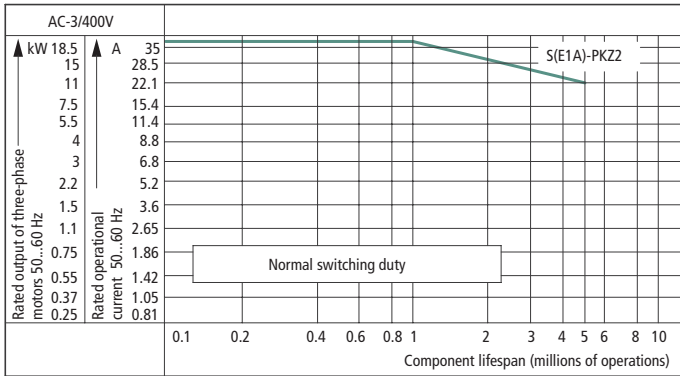

Squirrel-cage motor

Operating characteristics: Starting: From rest
Stopping: At full operating speed

Typical applications: Compressors Lifts Mixers
Pumps Escalators Agitators
Fans Conveyors Centrifuges
Valves Bucket-elevator Air-conditioning systems

General drives for manufacturing processing machines

Electrical characteristics: Starting: Up to 6 × rated motor current
Stopping: 1 × rated motor current

Utilization category: 100 % AC-3

Extreme switching duty

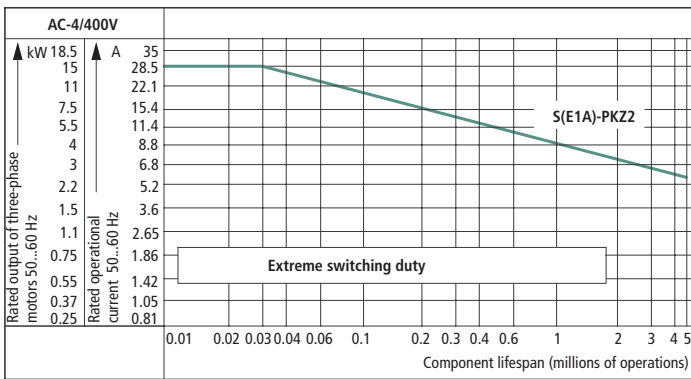

Squirrel-cage motor

Operating characteristics: Inching, plugging, reversing

Typical applications: Printing machines
Wire-drawing machine
Centrifuge
Special drives for manufacturing and processing machines

Electrical characteristics: Starting: 6 × rated motor current
Stopping: 6 × rated motor current

Utilization category: 100 % AC-4

Light switching duty

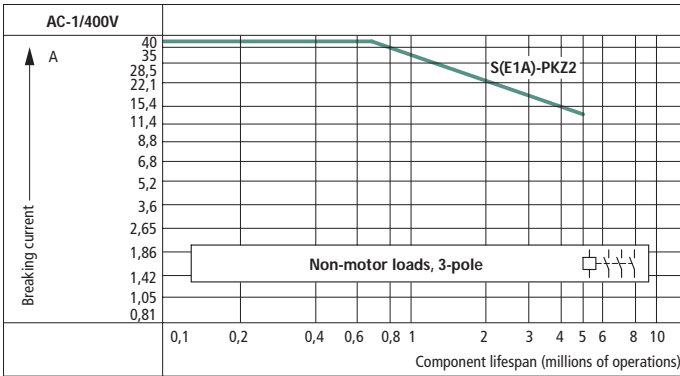

Non-motor loads

Operating characteristics: Non-inductive or slightly inductive loading

Typical applications: Electric heat

Electrical characteristics: Starting: Up to 1.5 × rated motor current
Stopping: 1 × rated motor current

Utilization category: 100 % AC-1

Determination of the maximum operating frequency dependant on the rating and utilization category (recommended values) for (high-capacity) contact modules

P_N = max. motor rating (kW)

S/h = max. operation per hour

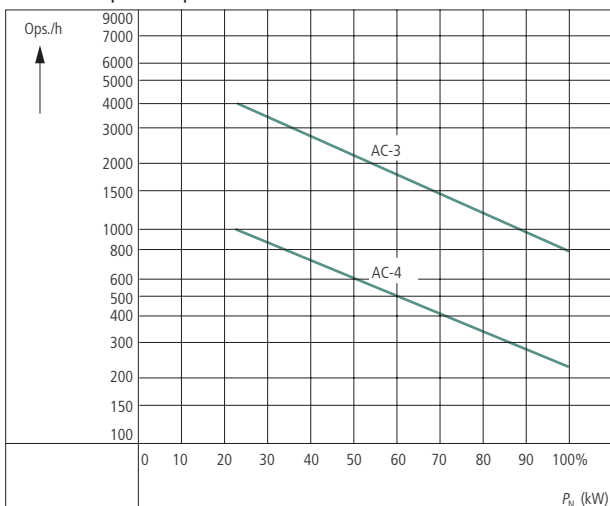

PKZ2 motor-protective circuit-breakers

Moeller HPL0211-2004/2005

Motor-protective circuit-breaker switching capacity and (high-capacity) compact starter

Rated uninterrupted current I_u

Rated conditional short-circuit current I_q IEC/EN 60947-4-1

Rated ultimate short-circuit breaking capacity I_{cu}
 Rated operational short-circuit breaking capacity I_{cs} } IEC/EN 60947-2

I_u A	230 V			1) A	400 V			1) A	440 V			1) A	500 V			1) A	690 V			1) A	
	I_q kA	I_{cu} kA	I_{cs} kA		I_q kA	I_{cu} kA	I_{cs} kA		I_q kA	I_{cu} kA	I_{cs} kA		I_q kA	I_{cu} kA	I_{cs} kA		I_q kA	I_{cu} kA	I_{cs} kA		
PKZ2/ZM with classification type "1" and "2"																					
0.16 – 1.6	N			N	N			N	N			N	N			N	N			N	
2.4	N			N	N			N	N			N	N			N	N			N	
4	N			N	N			N	N			N	N			N	4.5 4.5 2.5			63	
6	N			N	N			N	N			N	N			N	4.5 4.5 2.5			80	
10	30 N			30 N	30 N			30 N	10 10 5 80			7 7 3.5 80	4.5 4.5 2.5			80					
16	30 N			30 N	30 N			30 N	10 10 5 100			7 7 3.5 100	4.5 4.5 2.5			100					
25	30	30	7.5	160	30	30	7.5	160	10	10	5	125	7	7	3.5	125	4.5	4.5	2.5	125	
32	30	30	7.5	160	30	30	7.5	160	10	10	5	160	7	7	3.5	160	4.5	4.5	2.5	160	
40	30	30	7.5	160	30	30	7.5	160	10	10	5	160	7	7	3.5	160	4.5	4.5	2.5	160	
PKZ2/ZM + CL-PKZ2 with classification type "1" and "2"																					
0.16 – 1.6	N			N	N			N	N			N	N			N	N			N	
2.4	N			N	N			N	N			N	N			N	N			N	
4	N			N	N			N	N			N	N			N	10 4.5 2.5			N	
6	N			N	N			N	N			N	N			N	10 4.5 2.5			N	
10	30 N			30 N	30 N			30 N	5 N			3.5 N	10 4.5 2.5			N					
16	30 N			30 N	30 N			30 N	5 N			3.5 N	10 4.5 2.5			N					
25	7.5 N			7.5 N	7.5 N			7.5 N	5 N			3.5 N	10 4.5 2.5			N					
32	7.5 N			7.5 N	7.5 N			7.5 N	5 N			3.5 N	10 4.5 2.5			N					
40	7.5 N			7.5 N	7.5 N			7.5 N	5 N			3.5 N	10 4.5 2.5			N					
PKZ2/ZM(R)-.../SE1A(-G)... with classification type "1"																					
0.16 – 1.6	N N N			N N N	N N N			N N N	N N N			N N N	N N N			N N N	N N N			N N N	
2.4	N N N			N N N	N N N			N N N	N N N			N N N	N N N			N N N	N N N			N N N	
4	N N N			N N N	N N N			N N N	N N N			N N N	N N N			N N N	4.5 N N			63	
6	N N N			N N N	N N N			N N N	N N N			N N N	N N N			N N N	4.5 N N			80	
10	N N N			N N N	N N N			N N N	10 N N 80			7 N N 80	4.5 N N			80					
16	N N N			N N N	N N N			N N N	10 N N 100			7 N N 100	4.5 N N			100					
25	30	N	N	160	30	N	N	160	10	N	N	125	7	N	N	125	4.5	N	N	125	
32	30	N	N	160	30	N	N	160	10	N	N	160	7	N	N	160	4.5	N	N	160	
40	30	N	N	160	30	N	N	160	10	N	N	160	7	N	N	160	4.5	N	N	160	
PKZ2/ZM-.../S(-G) with classification type "1" and "2"																					
0.6 – 2.4	N N N			N N N	N N N			N N N	N N N			N N N	N N N			N N N	N N N			N N N	
4 – 6	N N N			N N N	N N N			N N N	N N N			N N N	N N N			N N N	10 N N			80	
10 – 16	N N N			N N N	N N N			N N N	N N N			N N N	N N N			N N N	10 N N			100	
25 – 40	N N N			N N N	N N N			N N N	N N N			N N N	N N N			N N N	10 N N			160	
PKZ2/ZM-...-8 and PKZ2/ZM-...-8/SE1A(-G)																					
0.16 – 1.6	N	N			N	N			N	N			N	N			N	N			N
2.4	N	N			N	N			N	N			N	N			N	N			N
4	N	N			N	N			N	N			N	N			N	4.5 2.5			63
6	N	N			N	N			N	N			N	N			N	4.5 2.5			80
10	N	30 N			N	30 N			N	10 5 80	N	7 3.5 80	N	4.5 2.5			80				
16	N	30 N			N	30 N			N	10 5 100	N	7 3.5 100	N	4.5 2.5			100				
25	N	30	7.5	160	N	30	7.5	160	N	10 5 125	N	7 3.5 125	N	4.5 2.5			125				
32	N	30	7.5	160	N	30	7.5	160	N	10 5 160	N	7 3.5 160	N	4.5 2.5			160				
40	N	30	7.5	160	N	30	7.5	160	N	10 5 160	N	7 3.5 160	N	4.5 2.5			160				
PKZ2/ZM-...-8/S(-G)																					
0.6 – 2.4	N	N			N	N			N	N			N	N			N	N			N
4 – 6	N	N			N	N			N	N			N	N			N	10 5			80
10 – 16	N	N			N	N			N	N			N	N			N	10 5			100
25 – 40	N	N			N	N			N	N			N	N			N	10 5			160

Notes

■ No upstream protective device required, as it is the auto-protected range (100 kA)
 N Not required

¹⁾ Fuse (A gG/gL) for enhancing the switching capacity of the motor-protective circuit-breaker to 100 kA



				PKZ2/ZM-...(8)	PKZ2/ZM-...(8)/SE...	PKZ2/ZM-...(8)/S(+CL)	S(EA)...	
General								
Standards				IEC/EN 60947, VDE 0660, UL 508, CSA C 22.2 No. 14, GL, LR, DNV, PRS, BV, RINA, RS, EZU, MEEI				
Climatic proofing				Damp heat, constant, to IEC 60068-2-78; Cyclic to IEC 60068-2-30				
Ambient temperature	Storage	°C	-25/70	-25/70	-25/70	-25/70		
	Open	°C	-25/60	-25/60	-25/60	-25/60		
	Enclosed	°C	-25/40	-25/40	-25/40	-25/40		
Mounting position								
Direction of incoming supply				As required				
Degree of protection				IP20	IP20	IP20	IP20	
Mechanical shock resistance								
Half-sinusoidal shock 20 ms to IEC 60068-2-27			g	30	8	8	8	
Altitude				m	max.2000	max.2000	max.2000	
Cross-sections	Solid or stranded	mm ²	1 × (1 – 16)	1 × (1 – 16)	1 × (1 – 16)	1 × (1 – 16)		
			2 × (1 – 6)	2 × (1 – 6)	2 × (1 – 6)	2 × (1 – 6)		
	Flexible with ferrule	mm ²	1 × (1.5 – 10) 2 × (1.5 – 6)	1 × (1.5 – 10) 2 × (1.5 – 6)	1 × (1.5 – 10) 2 × (1.5 – 6)	1 × (1.5 – 10) 2 × (1.5 – 6)		
Tightening torque	Solid or stranded	AWG	14 – 6	14 – 6	14 – 6	14 – 6		
	Main cable	Nm	1.8	1.8	1.8	1.8		
Control circuit cable		Nm	1	1	1	1		
Main contacts								
Rated impulse withstand voltage			U_{imp}	V AC	6000	6000	6000	
Overvoltage category/pollution degree					III/3	III/3	III/3	
Rated operational voltage			U_e	V AC	690	690	690	
Rated uninterrupted current = rated operational current				$I_u = I_e$	A	40	40	40
Rated frequency					Hz	50 – 60	50 – 60	50 – 60
Current heat loss (3-pole at operating temperature)					W	14	23	9
Lifespan, mechanical			Operations	× 10 ⁶	0.1	5	5	
Lifespan, electrical	100 % AC-3	Operations	× 10 ⁶	0.05	1	1	1	
	AC-4	Operations	× 10 ⁶	–	0.03	0.03	0.03	
Maximum operating frequency				Operations/h	Ops/h	60	a page 8/78	a page 8/78
Motor switching capacity	AC-3 up to 690 V	A	40	40	40	40		
	DC-5 up to 250 V	A	40	40	40	40		
DC application								
Rated short-circuit breaking capacity I_{cn}	250 V DC, L/R = 15 ms	kA	30	30	50	–		
	125 V DC	kA	50	50	65	–		
Switching times at short-circuit	Minimum command time	ms	Approx. 2	Approx. 2	Approx. 2	–		
	Opening delay	ms	Approx. 0.5	Approx. 0.5	Approx. 0.5	–		
	Total opening delay	ms	6	6	4	–		

Notes

¹⁾ With dual-frequency coil 50/60 Hz, the mechanical lifespan reduces by 30%

				ZM-...-PKZ2	ZMR-...-PKZ2	ZM-...-8-PKZ2(4)
Releases						
Function				Motor protection	Motor protection	System protection
Temperature compensation						
to IEC/EN 60947, VDE 0660			°C	-5/40	-5/40	-5/40
Operating range			°C	-25/60	-25/60	-25/60
Temperature compensation residual error for T > 20 °C				%/K	≤0.25	≤0.25
Short-circuit release tolerance				%	±20	±20
Overload release setting ranger				× I_u	0.6 – 1	0.6 – 1
Short-circuit releases				× I_u	8.5 – 14	8.5 – 14



(High-capacity) contact module PKZ2, PKZ2 current limiter

Moeller HPL0211-2004/2005

				S(EA)...
(High-capacity) contact module				
switching time	Closing delay		ms	9 – 30
	Opening delay		ms	4 – 12
Duty factor			% DF	100
Rated making capacity $\cos \varphi = 0.45$			A	400
Rated breaking capacity $\cos \varphi = 0.45$			A	400
Magnet systems				
AC operation				
Operating range	Pick-up voltage		$\times U_s$	0.85 – 1.1
	Drop-out voltage		$\times U_s$	0.4 – 0.6
Power consumption	Pick-up AC	Pick-up	VA	190
	Sealing AC	Sealing	VA	13
DC operation				
Rated control voltage		U_s	V DC	24
Operating range	Pick-up voltage		$\times U_s$	0.85 – 1.1
Power consumption	DC pick-up rating	Pick-up	VA	150
	Sealing DC	Sealing	VA	2.7
Current consumption	Pick-up current (16 – 22 ms)		A	6.3
	Holding current		mA	113
Rated operational current enclosed, open				
AC-1	230 V	I_e	A	40
	400 V	I_e	A	40
	440 V	I_e	A	40
	500 V	I_e	A	40
	690 V	I_e	A	40
AC-3	230 V	I_e	A	40
	400 V	I_e	A	40
	440 V	I_e	A	40
	500 V	I_e	A	40
	690 V	I_e	A	40
AC-4	230 V	I_e	A	30
	400 V	I_e	A	30
	440 V	I_e	A	30
	500 V	I_e	A	28
	690 V	I_e	A	25

				CL-PKZ2
Current limiter				
Rated making capacity $\cos \varphi = 0.45$			A	400
Rated breaking capacity $\cos \varphi = 0.45$			A	400
AC-1 operation	Conventional thermal current	I_{th}	A	40



				NHI11(S)-PKZ2	NHI22(S)-PKZ2	NHI2-11S-PKZ2	AGM2-11-PKZ2	
Auxiliary contacts								
Rated impulse withstand voltage	U_{imp}	V AC		6000	6000	6000	6000	
Overvoltage category/pollution degree				III/3	III/3	III/3	III/3	
Rated operational voltage	U_e	V AC		500	500	500	500	
Rated operational current								
AC-15	230 – 240 V	I_e	A	6	6	6	5	
	400 – 415 V	I_e	A	3	1.5	3	3	
	440 V	I_e	A	1.5	1.5	1.5	1.5	
	500 V	I_e	A	1.5	1.5	1.5	1.5	
Lifespan, mechanical	Operations	$\times 10^6$		0.1	0.1	5	0.01	
Lifespan, electrical	Operations	$\times 10^6$		0.05	0.05	1	0.005	
Contact reliability (at $U_e = 24$ V DC, $U_{min} = 17$ V, $I_{min} = 10$ mA)	Fault probability	λ		Control circuit reliability through the entire mechanical lifespan				
Positively driven contacts to ZH 1/457				–	–	Yes	Yes	
Short-circuit rating without welding								
Fuseless								
				240 V: PKZM0-6,3 415 V: PKZM0-4 500 V: PKZM0-1,6	240 V: PKZM0-6,3 415 V: PKZM0-4 500 V: PKZM0-1,6	240 V: PKZM0-6,3 415 V: PKZM0-4 500 V: PKZM0-1,6	240 V: PKZM0-6,3 415 V: PKZM0-4 500 V: PKZM0-1,6	
Fuse				A gG/gL	10	10	10	10
Cross-sections								
Solid or flexible conductor with ferrule				mm ²	1 \times (0.75 – 2.5) 2 \times (0.75 – 2.5)	1 \times (0.75 – 2.5) 2 \times (0.75 – 2.5)	1 \times (0.75 – 2.5) 2 \times (0.75 – 2.5)	1 \times (0.75 – 2.5) 2 \times (0.75 – 2.5)
Solid or stranded				AWG	1 \times (22 – 14) 2 \times (22 – 14)	1 \times (22 – 14) 2 \times (22 – 14)	1 \times (22 – 14) 2 \times (22 – 14)	22 – 14

				HI...-S-PKZ2	HI11-S/EZ-PKZ2	ZMR...(95 – 96)	ZMR...(97 – 98)	
Auxiliary contacts								
Rated impulse withstand voltage	U_{imp}	V AC		6000	6000	6000	6000	
Overvoltage category/pollution degree				III/3	III/3	III/3	III/3	
Rated operational voltage	U_e	V AC		500	500	500	500	
Rated operational current								
AC-15	230 – 240 V	I_e	A	6	6	1.5	1.5	
	400 – 415 V	I_e	A	1.5	3	0.7	0.5	
	440 V	I_e	A	1.5	1.5	0.5	0.3	
	500 V	I_e	A	1.5	1.5	0.5	0.3	
Lifespan, mechanical	Operations	$\times 10^6$		5	5	0.01	0.01	
Lifespan, electrical	Operations	$\times 10^6$		1	1	0.005	0.005	
Contact reliability (at $U_e = 24$ V DC, $U_{min} = 17$ V, $I_{min} = 10$ mA)	Fault probability	λ		Control circuit reliability through the entire mechanical lifespan				
Positively driven contacts to ZH 1/457				–	–	–	–	
Short-circuit rating without welding								
Fuseless								
				240 V: PKZM0-6,3 415 V: PKZM0-4 500 V: PKZM0-1,6	240 V: PKZM0-6,3 415 V: PKZM0-4 500 V: PKZM0-1,6	–	–	
Fuse				A gG/gL	10	10	10	10
Cross-sections								
Solid or flexible conductor with ferrule				mm ²	1 \times (0.75 – 2.5) 2 \times (0.75 – 2.5)	1 \times (0.75 – 2.5) 2 \times (0.75 – 2.5)	1 \times (0.75 – 2.5) 2 \times (0.75 – 2.5)	1 \times (0.75 – 2.5) 2 \times (0.75 – 2.5)
Solid or stranded				AWG	22 – 14	22 – 14	22 – 14	22 – 14



Moeller HPL0211-2004/2005

				U-PKZ2...	U-HI20-PKZ2...	UVHI-PKZ2
Undervoltage release						
Rated impulse withstand voltage	U_{imp}	V AC		6000	6000	6000
Overvoltage category/pollution degree				III/3	III/3	III/3
Cross-sections						
Solid or flexible conductor with ferrule		mm ²		1 × (0.75 – 2.5) 2 × (0.75 – 2.5)	1 × (0.75 – 2.5) 2 × (0.75 – 2.5)	1 × (0.75 – 2.5) 2 × (0.75 – 2.5)
Solid or stranded		AWG		22 – 14	22 – 14	22 – 14
Rated operational voltage	U_e	V AC		24 – 600	24 – 600	24 – 600
Rated operational voltage	U_e	V DC		24 – 125	24 – 125	24 – 125
Drop-out voltage	$\times U_s$	V		0.7 – 0.35	0.7 – 0.35	0.7 – 0.35
Power consumption						
AC						
Pick-up AC	Pick-up	VA		5	5	5
Sealing AC	Sealing	VA		3	3	3
DC						
DC pick-up rating	Pick-up	W		3	3	3
Sealing DC	Sealing	W		3	3	3
OFF-delay		ms		–	–	200
Rated operational current						
AC-15						
230 V	I_e	A		–	6	6
400 V	I_e	A		–	3	3
440 V	I_e	A		–	1.5	1.5

				A-PKZ2...
Shunt release				
Rated impulse withstand voltage	U_{imp}	V AC		6000
Overvoltage category/pollution degree				III/3
Cross-sections				
Solid or flexible conductor with ferrule		mm ²		1 × (0.75 – 2.5) 2 × (0.75 – 2.5)
Solid or stranded		AWG		22 – 14
Rated operational voltage	U_e	V AC		24 – 600
Rated operational voltage	U_e	V DC		24 – 250
Operating range				
AC		$\times U_s$		0.7 – 1.1
DC		$\times U_s$		0.7 – 1.1
Power consumption				
AC				
Pick-up AC	Pick-up	VA		5
Sealing AC	Sealing	VA		3
DC				
DC pick-up rating	Pick-up	W		3
Sealing DC	Sealing	W		0.3



			RE-PKZ2	RS-PKZ2
Remote operator				
Rated impulse withstand voltage	U_{imp}	V AC	6000	6000
Overtoltage category/pollution degree			III/3	III/3
Rated operational voltage	U_e	V AC	380 – 440	380 – 440
Rated operational voltage	U_e	V AC/DC	24 – 240	24 – 240
Safe isolation to VDE 0106 Part 101 and Part 101 A1 between the auxiliary contacts and main circuit		V AC	500	500
Required short-time rating (30 ms)		VA/W	700	700
Control transformer short-time rating		VA	1000	1000
Short-circuit voltage		%	4.4	4.4
Closing delay		ms	≤30	≤30
Break time		ms	≤30	≤30
Reset time to OFF		ms	≤30	≤30
Maximum operating frequency		Ops/h	60	60
Operating range	AC	$\times U_s$	0.85 – 1.1	0.85 – 1.1
	DC	$\times U_s$	0.85 – 1	0.85 – 1
Lifespan, electrical	Operations	$\times 10^6$	0.05	0.05
Integrated auxiliary contact (signal manual/automatic 33/34)				
Conventional free air thermal current	I_{th}	A	1.5	1.5
Rated operational current				
AC-14	230/240 V	I_e	A	1.5
	400/415 V	I_e	A	1
	440 V	I_e	A	0.5
Cross-sections				
Solid or flexible conductor with ferrule		mm ²	1 × (0.75 – 2.5) 2 × (0.75 – 2.5)	1 × (0.75 – 2.5) 2 × (0.75 – 2.5)
Solid or stranded		AWG	22 – 14	22 – 14

BK...-PKZ2, B3.1/...-PKZ2

Incoming terminal and three-phase commoning link				
Rated impulse withstand voltage	U_{imp}	V AC	6000	
Overtoltage category/pollution degree			III/3	
Rated operational voltage	U_e	V AC	690	
Rated uninterrupted current	I_u	A	120	



Moeller HPL0211-2004/2005

PKZM0, PKZM4, PKZ2 in 1 and 2-pole circuits with DC and AC current



Protection of PVC insulated cables against thermal overload at short-circuit

The table indicates which minimum cable cross-sections are protected by PKZ(M) motor-protective circuit-breakers up to their rated conditional short-circuit current I_{cc} .

Min. cross-section protected 380 – 415 V, 50 Hz, Cu mm ²					Device Type
4	2.5	1.5	1	0.75	
					PKZM0-0,16
					PKZM0-6,3
					PKZM0-10
					PKZM0-16
					PKZM0-20
					PKZM0-25
					PKZM4-16
					PKZM4-25
					PKZM4-32
					PKZM4-40
					PKZM4-50
					PKZM4-58
					PKZM4-63

Min. cross-section protected 380 – 415 V, 50 Hz, Cu mm ²					Device Type
4	2.5	1.5	1	0.75	
					PKZ2/ZM-0,6
					PKZ2/ZM-2,4
					PKZ2/ZM-4
					PKZ2/ZM-6
					PKZ2/ZM-10
					PKZ2/ZM-16
					PKZ2/ZM-25
					PKZ2/ZM-32
PKZ2/ZM-40					

Fuseless installation with PKZ(M), back-up-protection diagrams

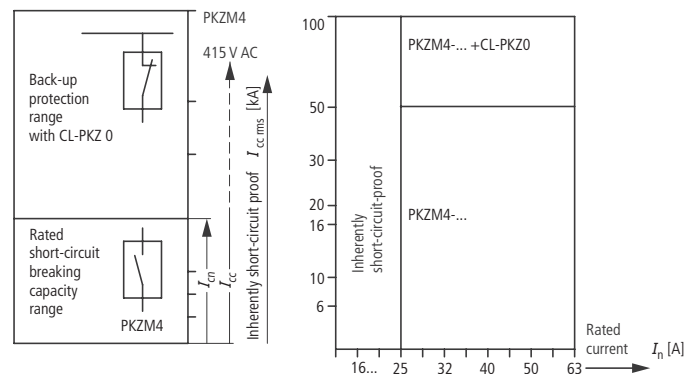
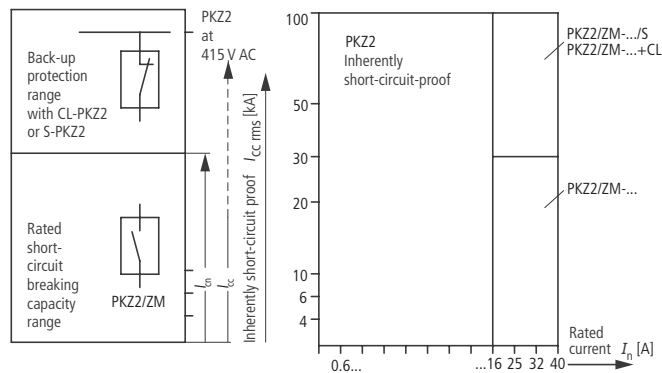
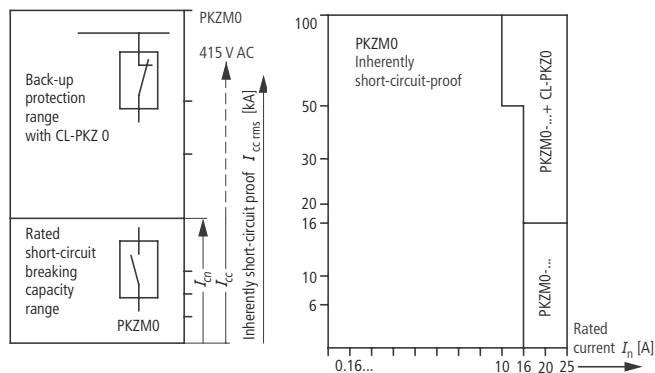

Motor-protective circuit-breakers

PKZM01

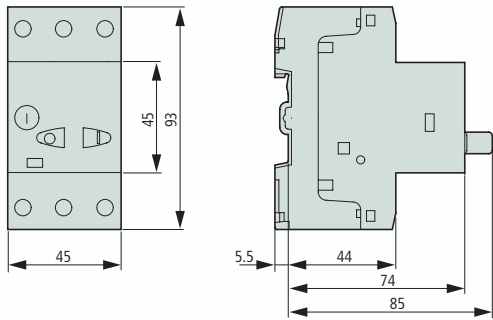

Motor-protective circuit-breakers, transformer-protective circuit-breakers

PKZM0-...(+NHI-E-...-PKZ0)
 PKZM0-...T
 PKM0-...

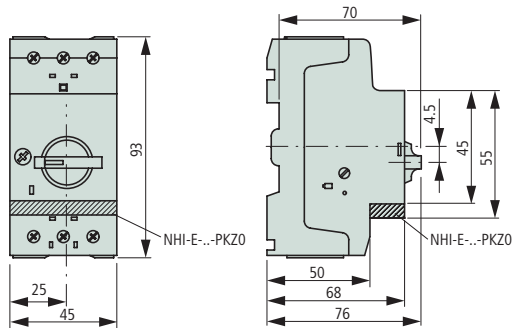

Motor-protective circuit-breakers with lockable rotary handles

PKZM0-... +AK-PKZ0

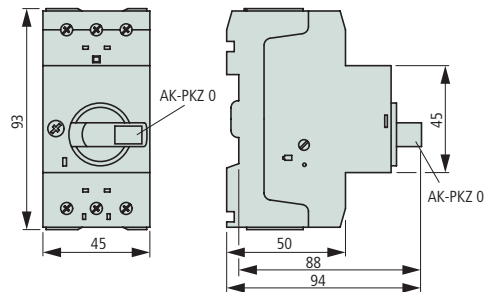

Current limiter

CL-PKZ

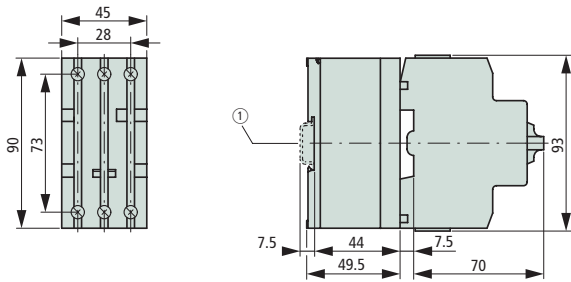

① IEC/EN 60715 top-hat rail

Motor-protective circuit-breakers with early-make auxiliary contacts

PKZM0-...+VHI-...-PKZ0

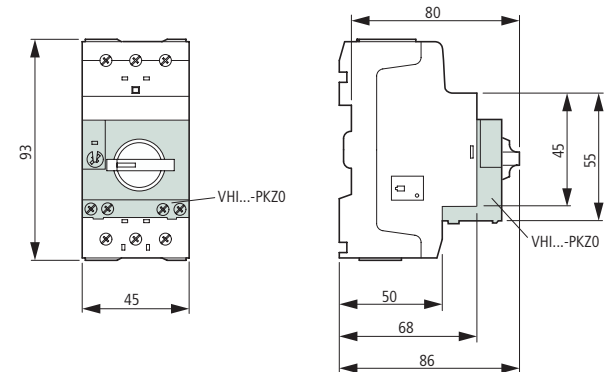

PKZM0 motor-protective circuit-breakers

Moeller HPL0211-2004/2005

(High-capacity) compact starters

PKZM0-.../S(E)00 (+NHI-E-...-PKZ0)

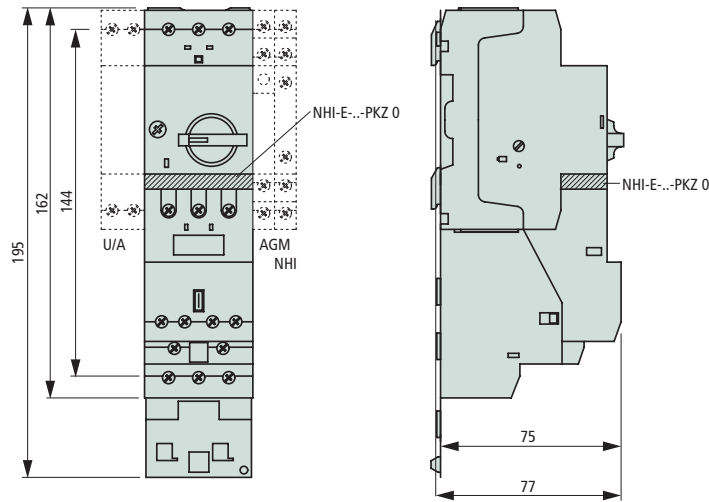

Standard auxiliary contact for (H-) compact starter

NHI 2-11S-PKZ0

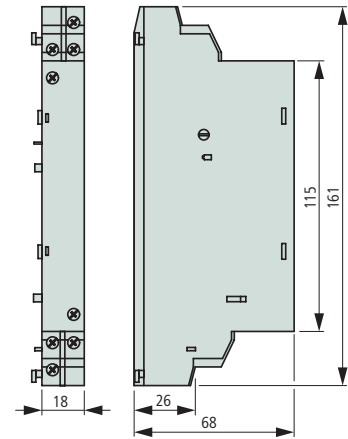

Standard auxiliary contact

NHI...-PKZ0

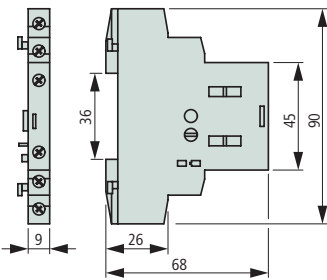

Trip-indicating auxiliary contact

AGM2-...-PKZ0

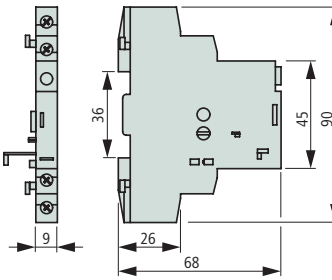

Voltage release

U/A-PKZ0

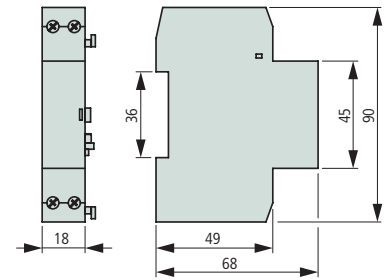

(High-capacity) contact module

S(E)00-PKZ0

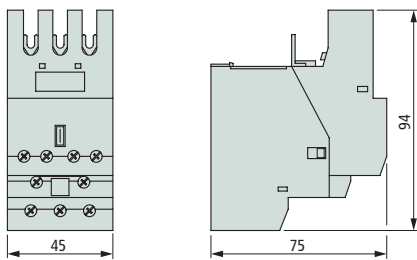

Separate mounting

EZ-PKZ0

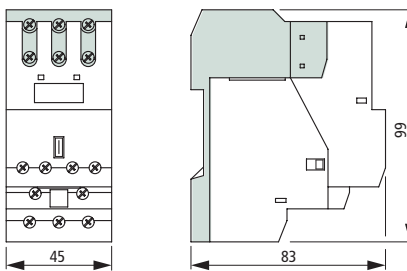

Auxiliary contacts for (high-capacity) contact module

HI11-S/EZ-PKZ0

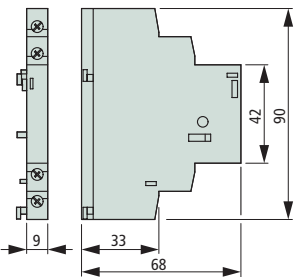

Mechanical interlock (high-capacity) contact module

MV-PKZ0

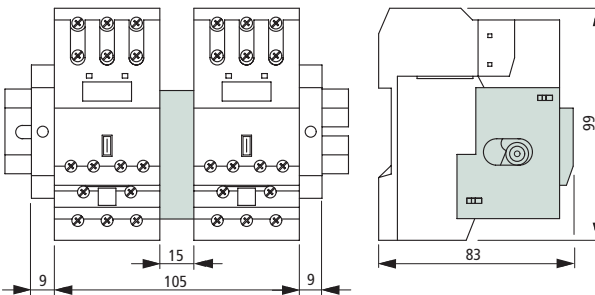

Three-phase commoning link

B3.0/4-PKZ0
 B3.0/2-PKZ0

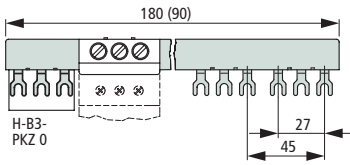

Three-phase commoning link

B3.2/4-PKZ0
 B3.2/2-PKZ0

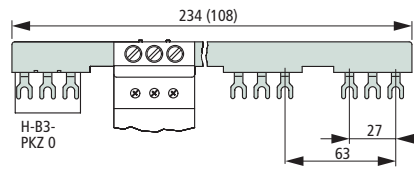

Three-phase commoning link

B3.1/5-PKZ0
 B3.1/4-PKZ0
 B3.1/3-PKZ0
 B3.1/2-PKZ0

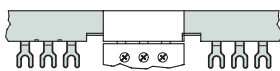
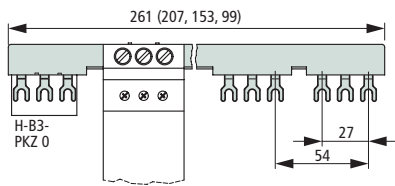

Overlapping mounting to extend the three-phase commoning link

Incoming terminal

BK25/3-PKZ0

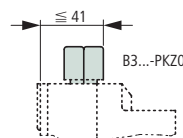
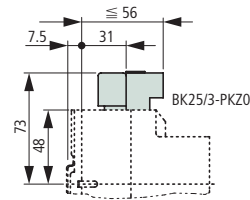

Insulated enclosures for surface mounting

CI-PKZ0

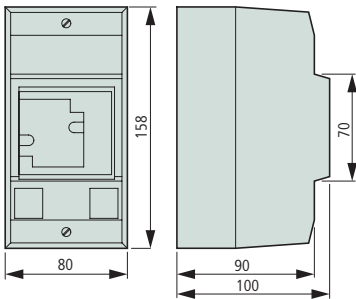

CI-PKZ0-G(R)(V)

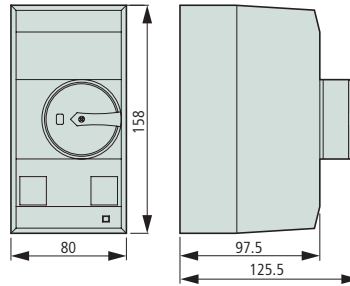

CI-PKZ0-G(R)(V)
 +SVB-PKZ0-CI

CI-PKZ0... drilling dimensions

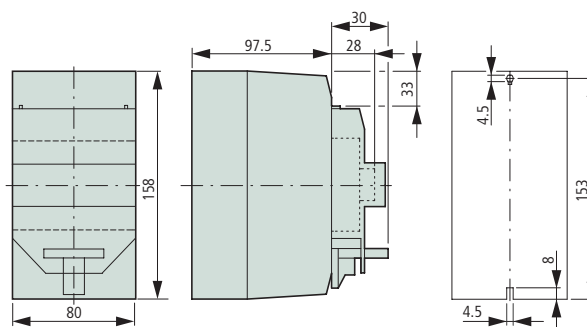
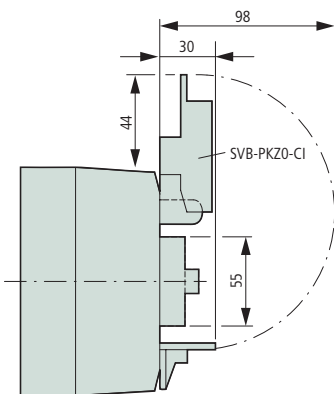

Moeller HPL0211-2004/2005

Insulated enclosures for surface mounting

CI-PKZ01/CI-PKZ01-G

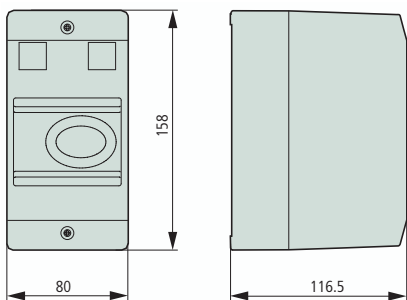

CI-PKZ01-PVT/CI-PKZ01-PVS

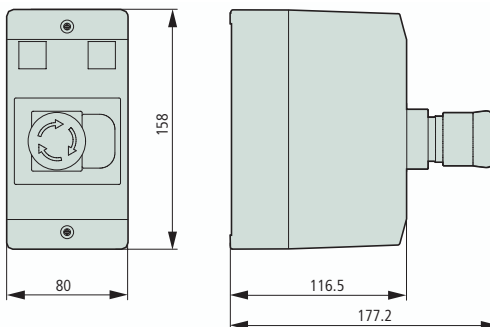

CI-PKZ01-SVB(-V)

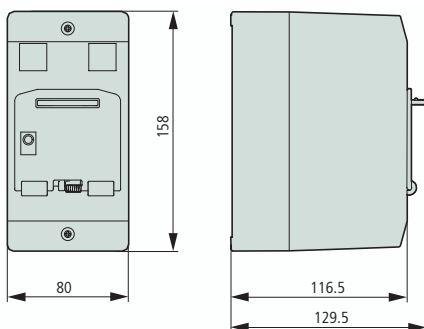

Insulated enclosures for flush mounting

E-PKZ01(-G)

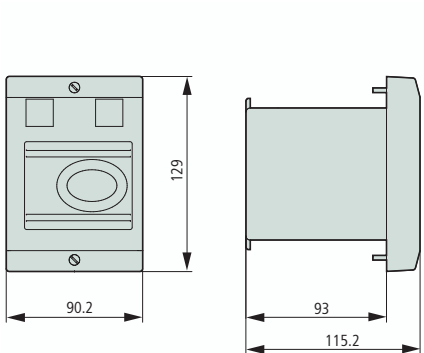

E-PKZ01-PVT/E-PKZ01-PVS

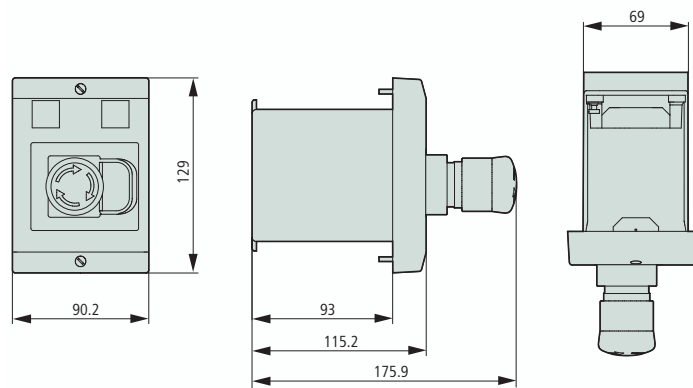

E-PKZ01-SVB(-V)

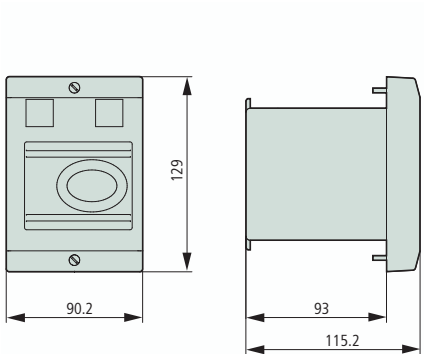

Insulated enclosures for surface mounting

CI-K2-PKZ0

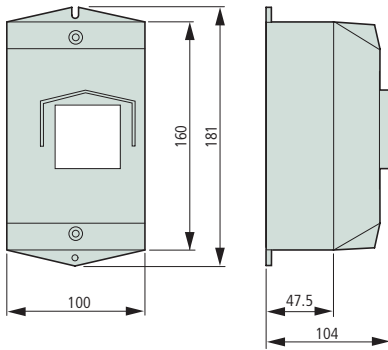

CI-K2-PKZ0G(R)(V)

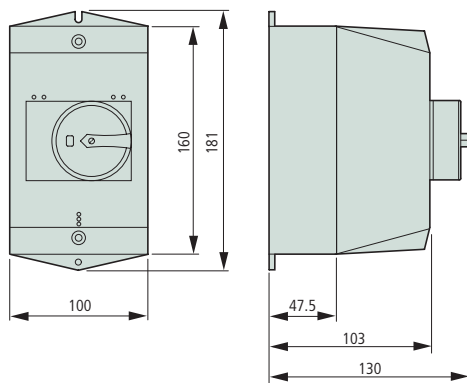

CI-K2-PKZ0-G(R)(V)
 + SVB-PKZ0-CI

CI-K2-PKZ0... drilling dimensions

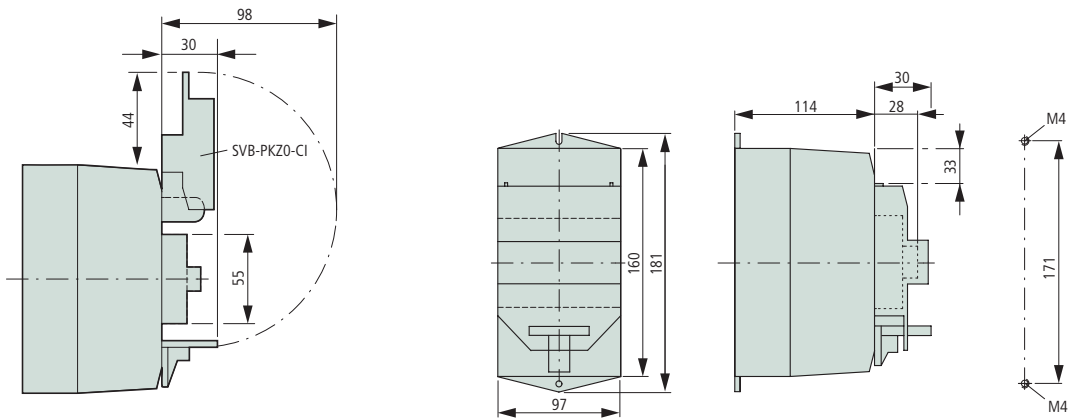

PKZM0 motor-protective circuit-breakers

Moeller HPL0211-2004/2005

Insulated enclosures for surface mounting

CI23E

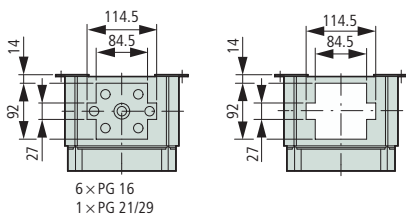
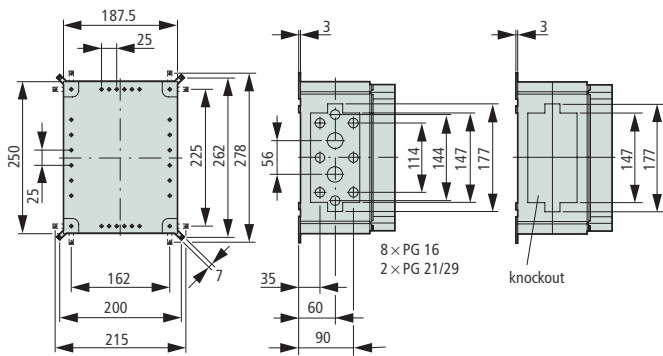

Door coupling handle

(R)H-PKZ0, HSOV-PKZ0

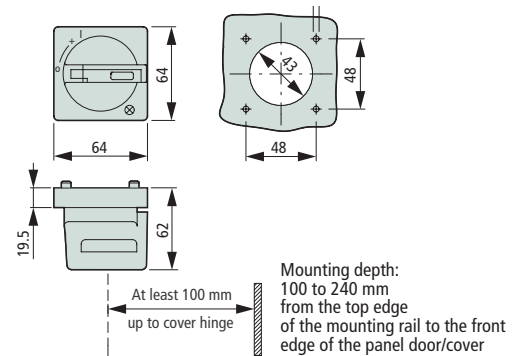

Mounting plate

M3-CI23

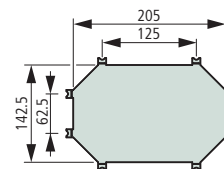

Insulated enclosures for flush mounting

E-PKZ0
E-PKZ0-G(R)

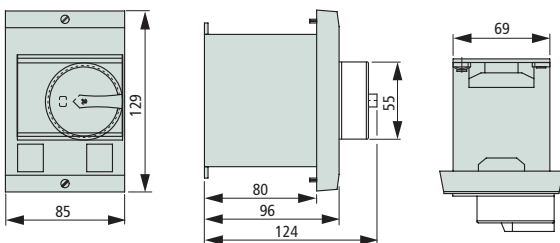

Mounting aperture
E-PKZ0...

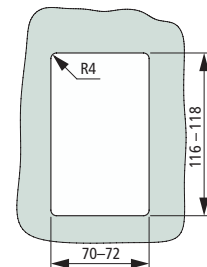

E-PKZ0-G(R)
+ SVB-PKZ0-E

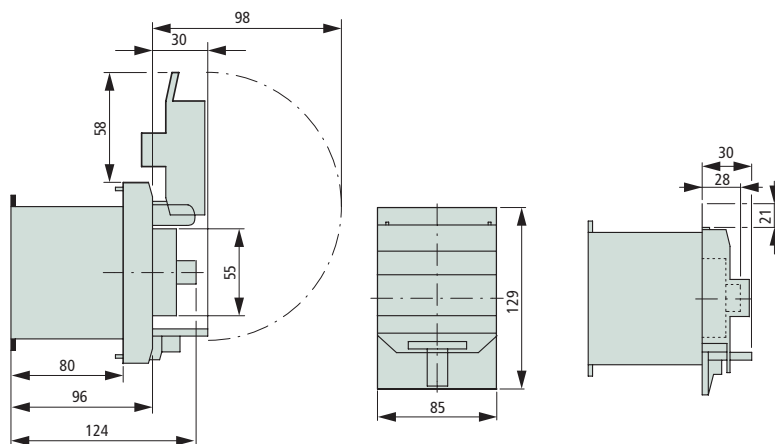

Component adapter

AD25/5(10)-1

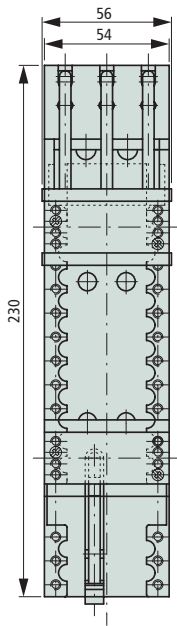

AD25/5(10)-2

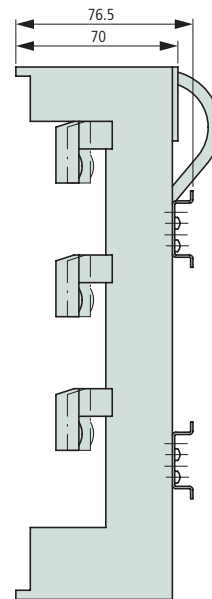
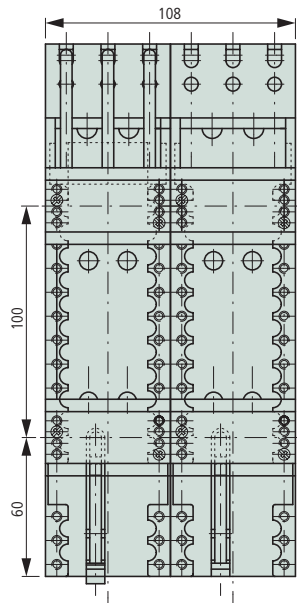

AD25/5(10)-144

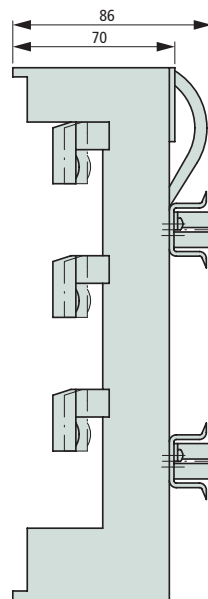
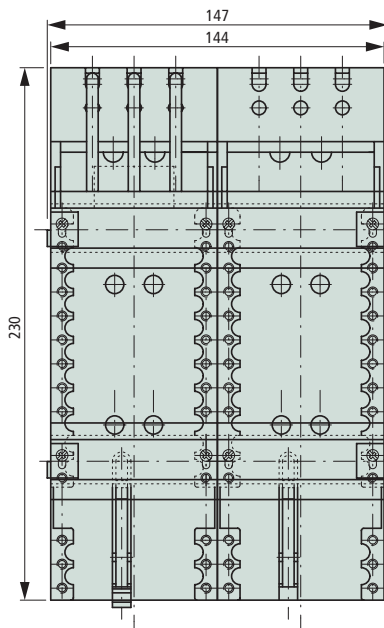

PKZM4 motor-protective circuit-breakers

Moeller HPL0211-2004/2005

Motor-protective circuit-breakers

PKZM4

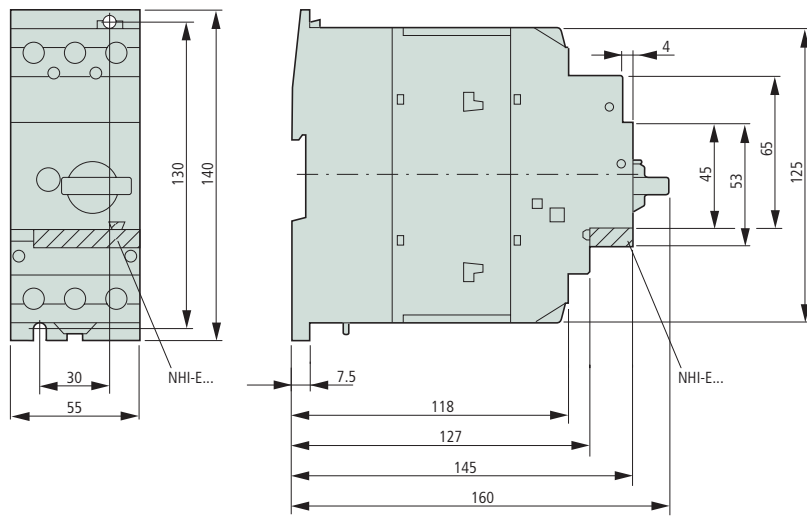

Motor-protective circuit-breakers with lockable rotary handles

PKZM4...+AK-PKZO

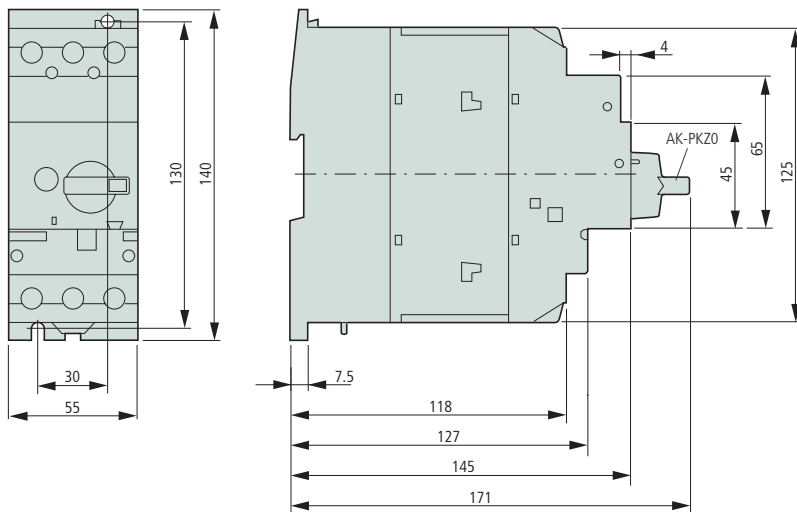

Auxiliary contact and trip-indicating auxiliary contact dimensions a 8/88



Insulated enclosures for surface mounting

CI-K4-PKZ4-G(R)

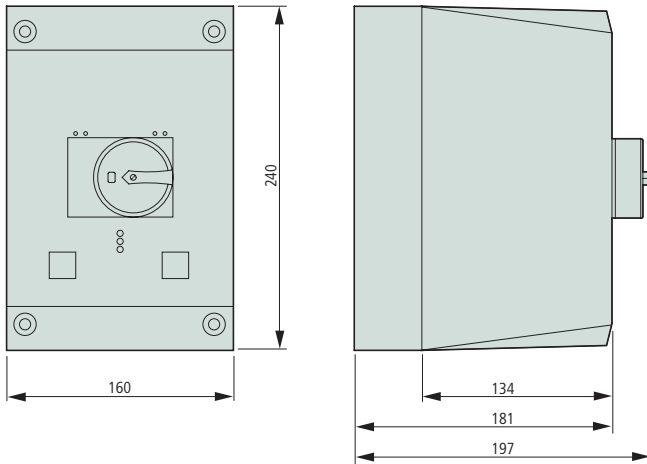

CI-K4-PKZ4-G(R)
 +SVB-PKZ4-CI

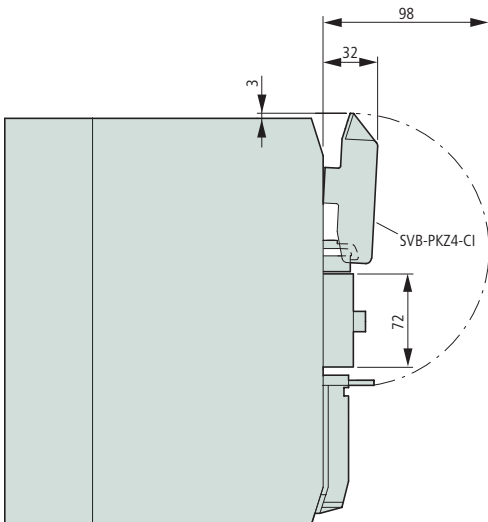

CI-K4-PKZ4-G(R)
 drilling dimensions

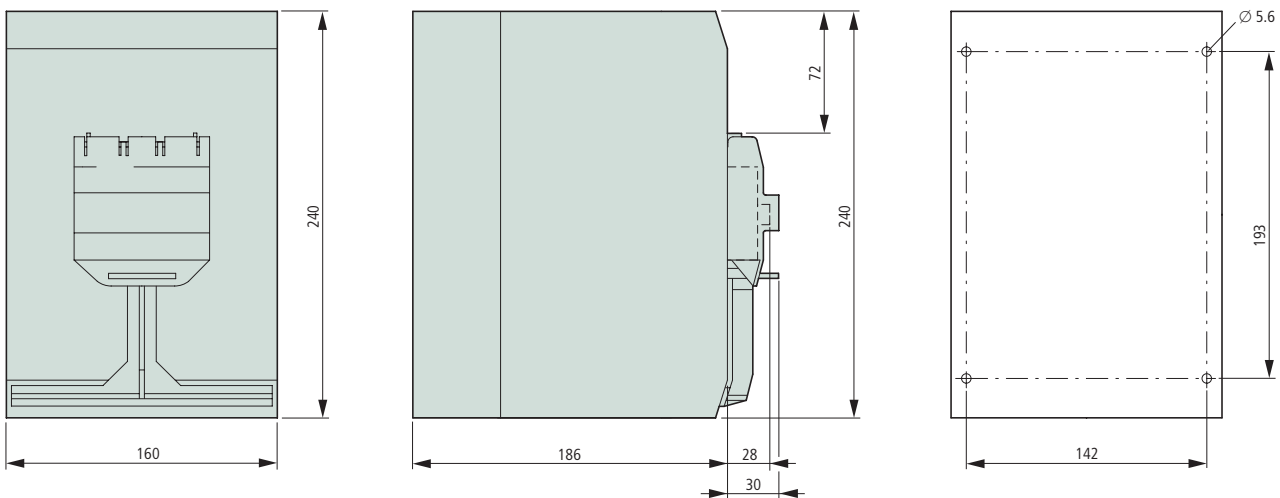

PKZM4 motor-protective circuit-breakers

Moeller HPL0211-2004/2005

Three-phase commoning link
B3.0/4-PKZ4

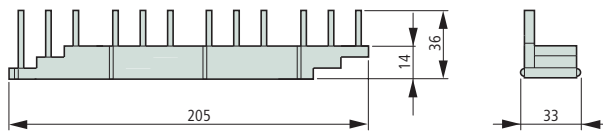

Three-phase commoning link
B3.2/4-PKZ4

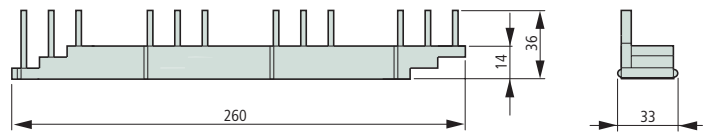

B3.0/3-PKZ4

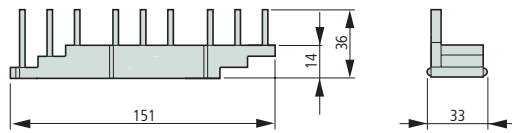

B3.2/2-PKZ4

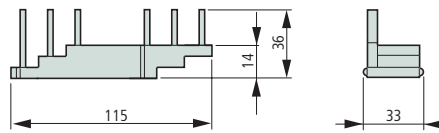

B3.0/2-PKZ4

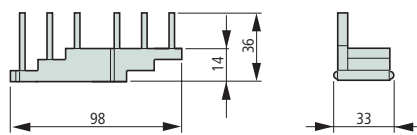

Three-phase commoning link
B3.1/4-PKZ4

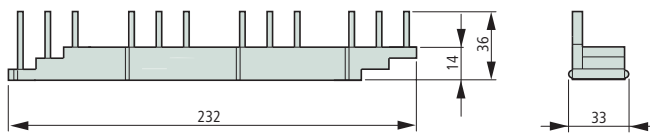

B3.1/3-PKZ4

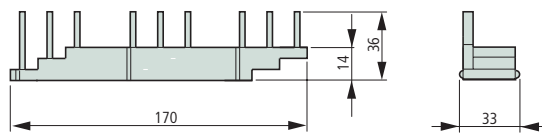

B3.1/2-PKZ4

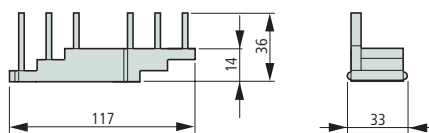

Circuit-breaker, trip block

PKZ2/(Z)M-...,
ZMR-...-PKZ2

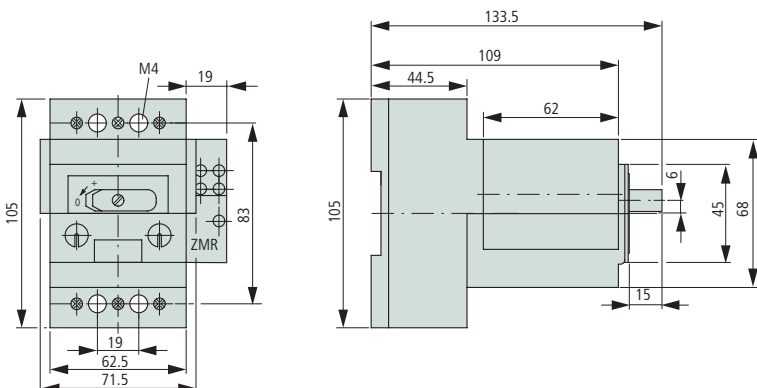

Trip-indicating auxiliary contact

AGM 2-11-PKZ2

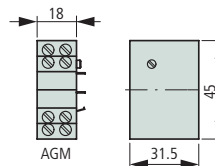

Circuit-breaker

PKZ24/(Z)M-...

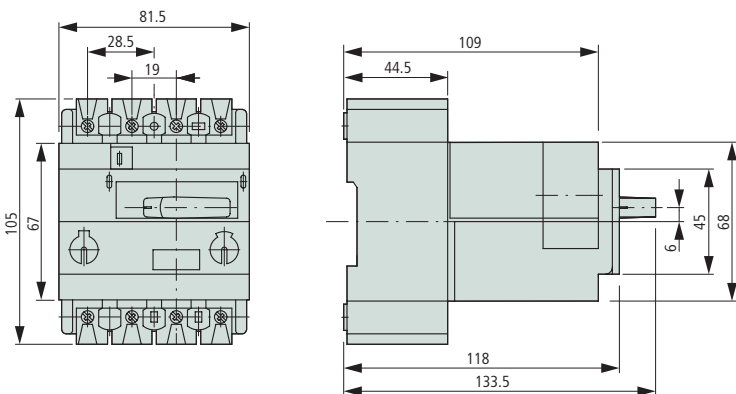

Standard auxiliary contact

NHI...PKZ2

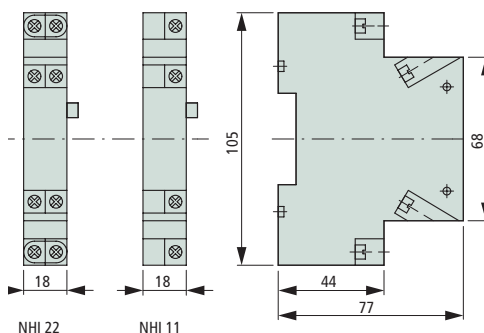

Remote operator

RE-PKZ2 (...)
RS-PKZ2 (...)

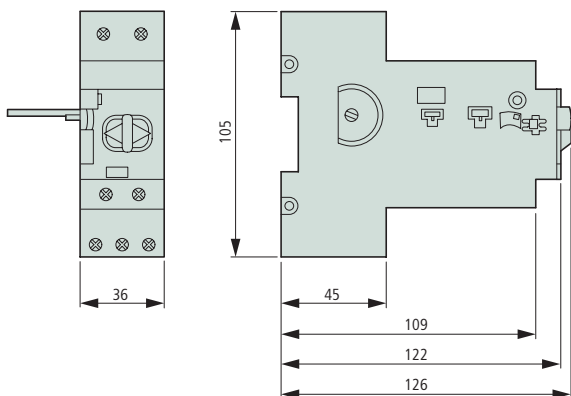

Voltage releases

U-PKZ2 (...)
A-PKZ2-...

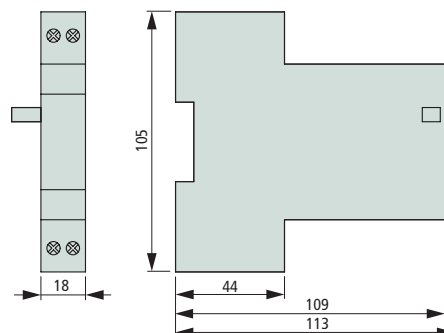

Moeller HPL0211-2004/2005

(High-capacity) compact starter

PKZ2/ZM-.../S(-SP)
 PKZ2/ZM-.../SE1A...
 PKZ2/ZM-.../S-G

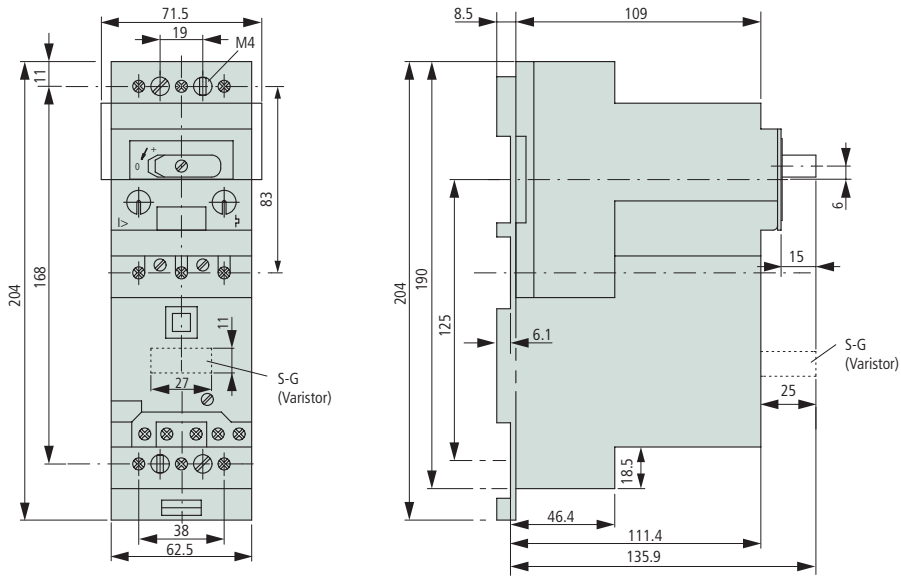

Standard auxiliary contact for (H-) compact starter

NHI...S-PKZ2

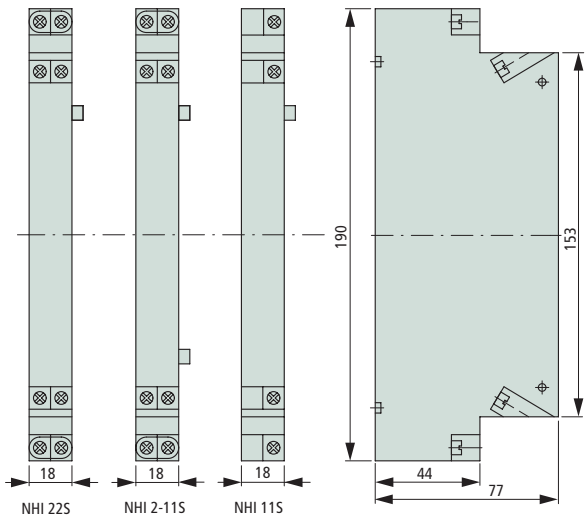

SE1A(-G) contact module
 S(-G) high-capacity contact module
 CL current limiter

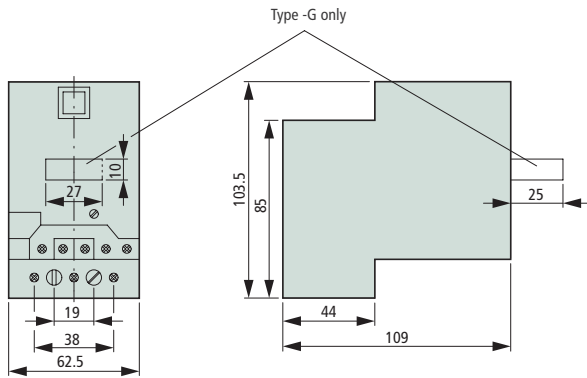

EZ base for separate mounting
 HI11-S/EZ standard auxiliary switch for EZ separate mounting

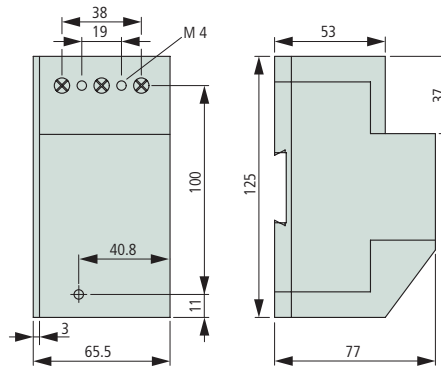

Neutral conductor module for (H-)contact module

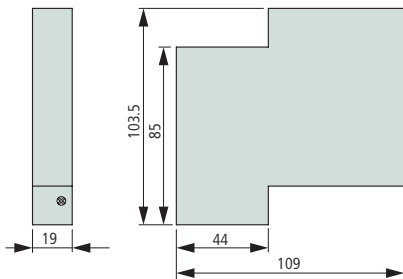

Insulated enclosures for surface mounting

CI19EA-PKZ2

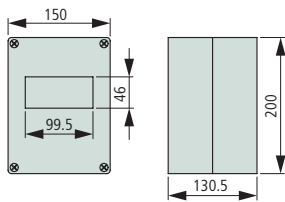

CI19EB-PKZ2
 CI19ED-PKZ2

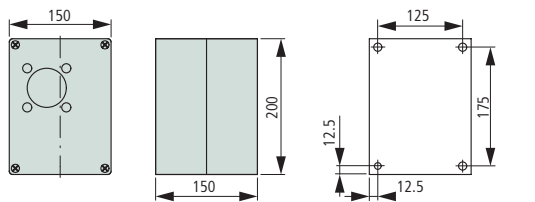

CI23EA-PKZ2

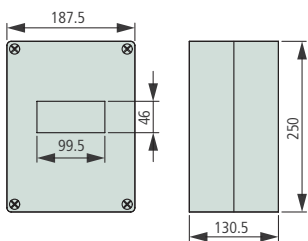

CI23EB-PKZ2

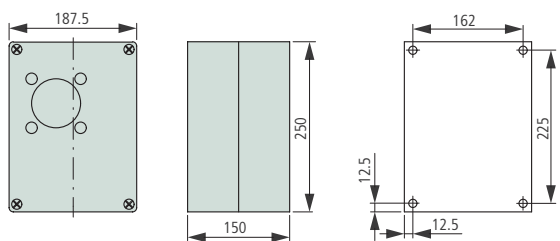

Moeller HPL0211-2004/2005

Insulated enclosures for flush mounting

E-PKZ2
E-54-PKZ2

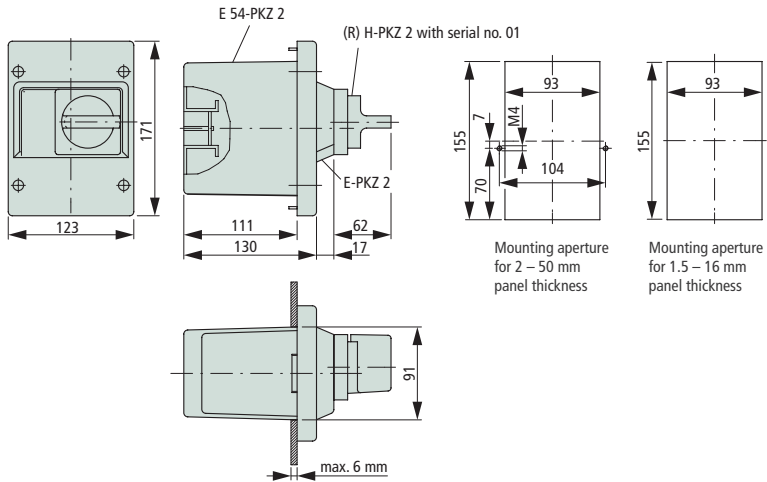

Door coupling handle

(R)H-PKZ2

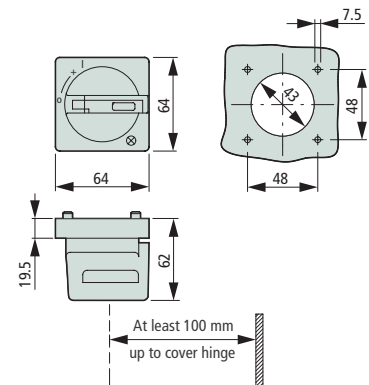

Three-phase commoning link

B3.1/3-PKZ2

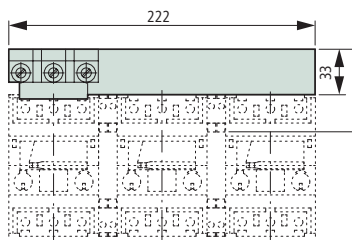

Three-phase commoning link

B3.1/2-PKZ2

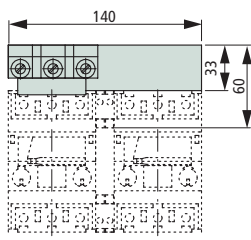

Incoming terminal

BK50/3-PKZ2

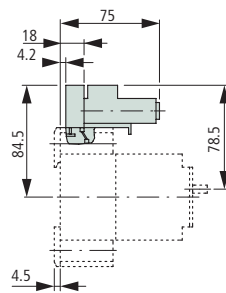

Shroud for unused terminals

HB-3-PKZ2
2

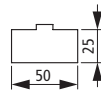

Mechanical interlock (high-capacity) contact module

MV-PKZ2

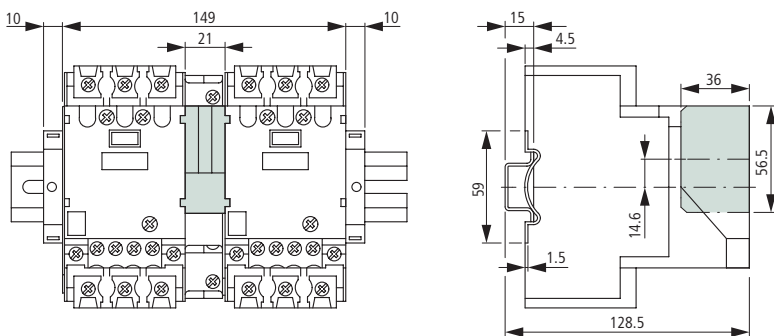

8/100 Dimensions

PKZ2, PKZM4 motor-protective circuit-breakers

Moeller HPL0211-2004/2005

Motor-protective circuit-breakers

Component adapter

AD40/5(10)-1
AD63/5(10)-1

AD40/5(10)-2

