

Temperature Sensors G1/2" standard



Application

- temperature measurement in pipes and vessels
- without direct contact of the sensor to the product
- remove the sensor without opening the process

Application Examples

- temperature measurement in pressure pipes
- measuring of paste products in pipes
- temperature monitoring in milk tanks

Hygienic Design / Process Connection

- hygienic measurement point which is easy to sterilize in connection with our weld-in sleeve ESH
- CIP-/ SIP-cleaning up to 140°C
- food compatible materials according to FDA
- sensor completely made of stainless steel

Features

- defined position of the cable entry
- available with and without integrated transmitter
- different kinds of electrical connections available

Options / Accessories

- 2xPt100
- transmitter mpu-4 with output 4-20mA, 2-wire
- programmable transmitter mpu-4p
- insertion length from 50mm up to 2000mm available
- transmitters for PROFIBUS, HART, EX-zone
- integrated LC-display mpu-LCD in the connecting head
- Pt100 chip with other classes of accuracy, e.g. 1/3 DIN B, 1/10 DIN B
- fast response sensor tip 3mm und 4mm
- neck tube for temperature up to 250°C
- cables available in PTFE and other lengths

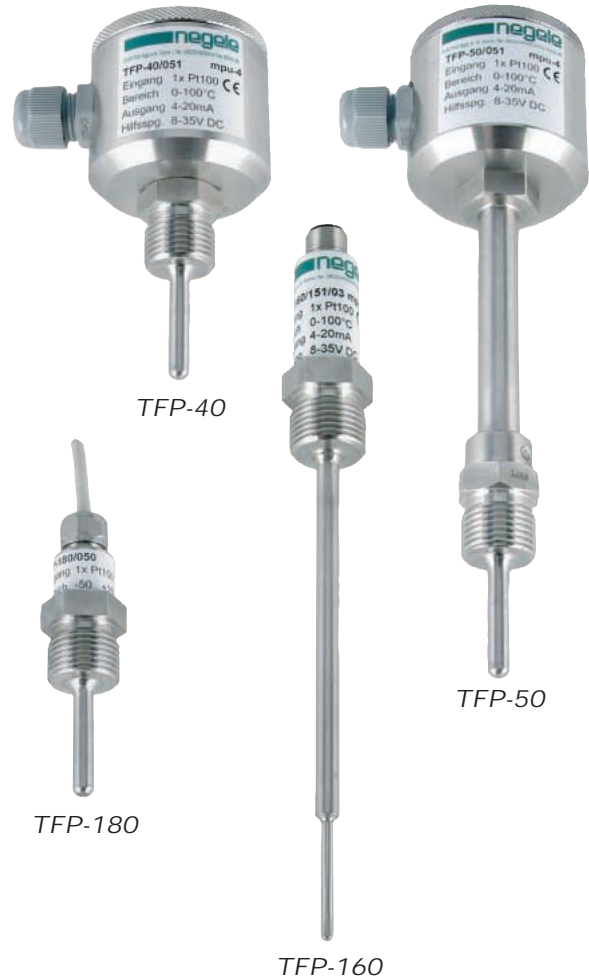

Order Code

Temperature sensor	Model head Ø55mm	Insertion length [mm]	Transmitter	Range	Electrical connection	Diameter sensor tip	Further options
TFP-40		50, 150, 250mm	without*	-10...+40°C	PG*	3mm	1/3B
TFP-50	neck tube	special length	mpu-4	0...50°C	M12	4mm	1/10B
TFP-... / ..2	2xPt100		mpu-4p (programmable)	0...100°C		6mm*	2xPG** 2xM12**
			mpu-10 (Profibus PA)	0...150°C			
			mpu-4ex (EX-zone)	0...200°C			
			mpu-H (HART protocol)				
			mpu-LCD (integ. display)				
Order example:		TFP-40 / 150 / mpu-4 / 0...150°C / M12 / 4mm / 1/3B				** only for model 2xPt100.	
Temperature sensor	Model head Ø19mm	Insertion length [mm]	Transmitter mpu-m	Range	Electrical connection	Diameter sensor tip	Further options
TFP-160	M12-plug	50, 150, 250mm	.m	-10...+40°C	M12*	3mm	1/3B
TFP-180	fixed cable	special length		0...50°C	cable*	4mm	1/10B
				0...100°C		6 mm*	PTFE cable (TFP-180 only)
				0...150°C			
				0...200°C			
Order example:		TFP-160 / 150 .m / 0...150°C / 4mm				*standard, no declaration needed.	



Specification Temperature Sensor

Process connection	hygienic	weld-in sleeve e.g. ESH-G1/2" / O50
Insertion length	standard	50, 150, 250mm
Material	head	stainless steel 303 (1.4305)
	protection tube	316 L (1.4404)
Sensing resistor	acc. DIN ITS 90	1xPt100 class A
Operating pressure	with ESH	50bar

Temperature range	ambient	-50...+80°C
	sensor tip	-50...+250°C
electrical connection	cable junction	M16x1,5 (PG)
	plug-in	M12-plug 303 (1.4305) 4pins
	fixed cable 2,5m option (>90°C)	LIYY 4x0,25mm ² PTFE 4x0,14mm ²
Protection class		IP69K

Transmitter mpu-4, -4p, -10, -4ex, -HART

Temperature range	standard	-10...+40, 0...50°C 0...100 / 150 / 200°C
Accuracy		<±0,1% (full scale)
Temperature drift	zero, span	<0,01%/K (full scale)
Electrical connection	supply	8...35VDC
Output	analog	4-20mA
Temperature range	ambient	-40...+85°C
	storage	-40...+120°C
Humidity	without condensate	0...98%

Transmitter mpu-m

Temperature range	standard	-10...+40, 0...50°C 0...100 / 150 / 200°C
Accuracy		<±0,2% full scale
Temperature drift	zero, span	<0,02% full scale /K
Electrical connection	supply	12...36VDC
Output	analog	4-20mA
Temperature range	ambient	-50...+80°C

Accuracy Class Pt100

Tolerances of Pt100 acc. ITS 90

Pt100	class B	class A	class 1/3B	class 1/10B
0°C	±0,3K	±0,15K	±0,10K	±0,03K
100Ω	±0,12Ω	±0,06Ω	±0,04Ω	±0,01Ω
100°C	±0,8K	±0,35K	±0,27K	±0,08K
138,5Ω	±0,30Ω	±0,13Ω	±0,10Ω	±0,03Ω

Sensor tip diameter and response time

All temperature sensors are available with smaller sensor tips, to ensure a shorter response time. The below-mentioned times are according to a PT100 sensor in boiling water.

Sensor tip ø6mm with thermowell

validity: $t_{50} \leq 8,8s$
90%-time: $t_{90} \leq 24,5s$

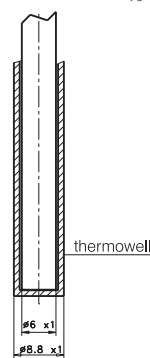

Sensor tip ø6mm

validity: $t_{50} \leq 3,0s$
90%-time: $t_{90} \leq 8,0s$

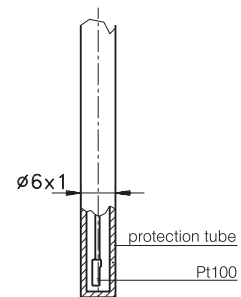

Option: mpu-LCD

integrated LC-Display in the connection head

Specifications: please look on separate product informations



temperatur sensor
with mpu-LCD
(view from top)

Features

- 4-digit display with green backlight
- temperature measurement in °C und °F
- easy range select by one button
- direct connection to the PLC
- lower costs for wiring because of 2-wire technology
- suitable for sensor monitoring

Sensor tip ø4mm

validity: $t_{50} \leq 2,4s$
90%-time: $t_{90} \leq 6,5s$

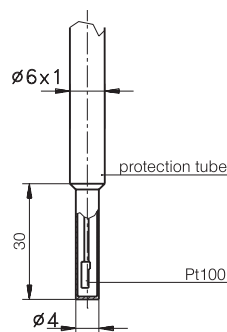

Sensor tip ø3mm

validity: $t_{50} \leq 0,5s$
90%-time: $t_{90} \leq 1,5s$

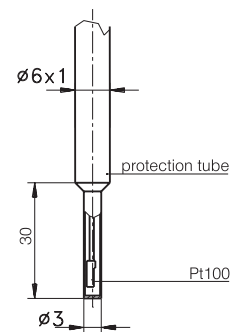

Accessories



Simulator hsg-3



Calibration Device htr

Drawings

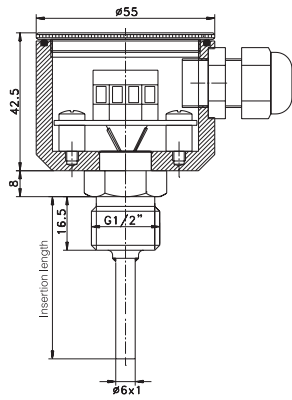

TFP-40

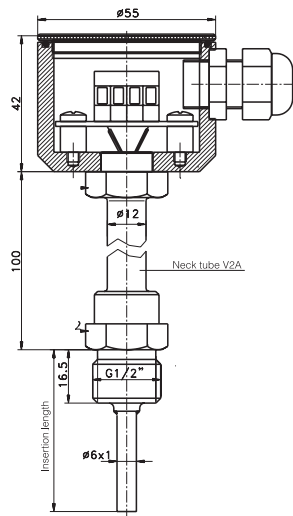

TFP-50

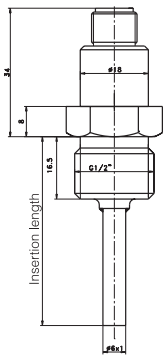

TFP-160

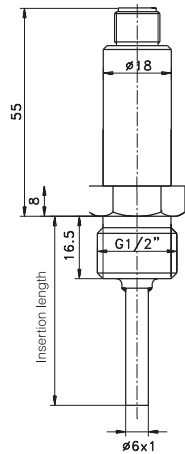

TFP-160.m

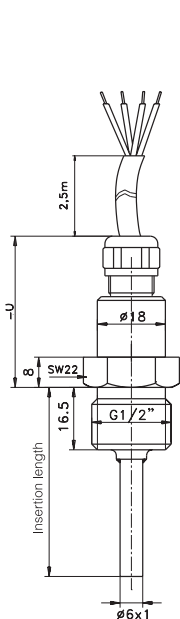

TFP-180

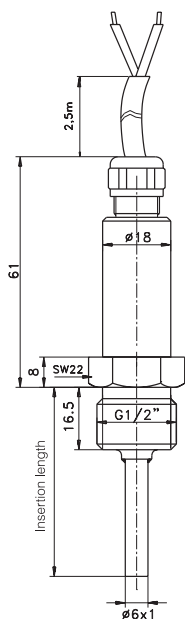

TFP-180.m

Electrical connections

without transmitter

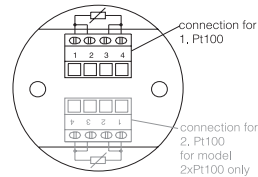

with transmitter
mpu-4, -4p, -4ex, -10, -HART

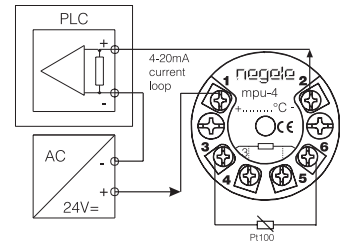

without transmitter
M12 connection
(view from the top)

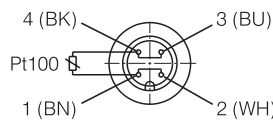

with transmitter mpu-m
M12 connection
(view from the top)

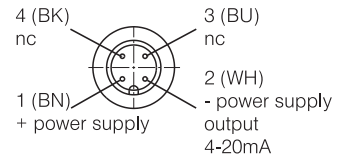

without transmitter
cable connection

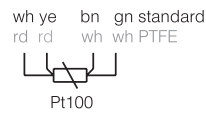

option 2xPt100
cable connection

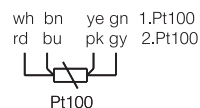

with transmitter mpu-m
cable connection

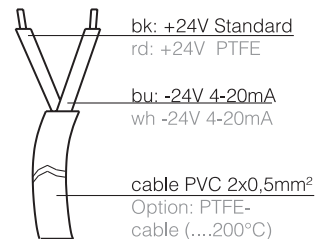

Drawing thermowell

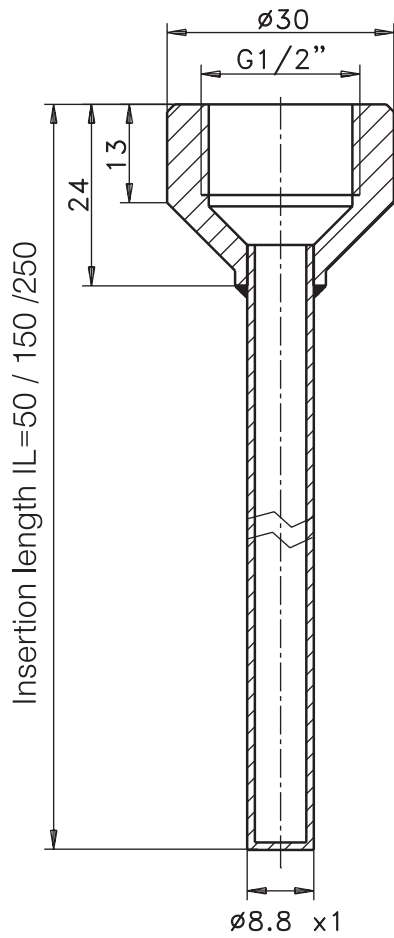

ESH-G1/2"